



State of Wisconsin \ Department of Commerce

Formatted: Left: 1", Right: 1"

# RULES IN FINAL DRAFT FORM

**Rule No.:** Chapters Comm 62 and 81 to 84

**Relating to:** Wisconsin Uniform Plumbing Code  
and Commercial Building Code

**Clearinghouse Rule No.:** 08-055

The Department of Commerce proposes an order to:

amend ss. Comm 62.2900(1), Comm 81.01(5), Comm 81.01(79), Comm 81.01(115), (120) and (147), Comm 81.01(156), Comm 81.01(163), Comm 81.01(189), Comm 81.01(204), Comm 81.01(234), Comm 81.01(269) and (288), Comm 81.20(1), Tables Comm 81.20-1 to 81.20-9, Tables Comm 81.20-11 to 81.20-13, Comm 82.20(1)(c)(intro.), (4)(b)2. and (13)(e), Tables Comm 82.20-1 line 7 and 82.20-2 line 6 and Footnote a, Comm 82.21 Title, Comm 82.21(1)(intro.), Comm 82.30(3), Table Comm 82.30-1, Comm Table 82.30-3, Comm 82.30(6)(a)2. and (b)1. and 2., Comm 82.30(10)(a)1., Comm 82.31(4)(a), Comm 82.31(10)(c), (13)1. e., (14)(g)2. and (17)(a)1. e., Comm 82.31(17)(b)1. and 3. a., Comm 82.33(9)(c)1. a. and b., Comm 82.33(9)(f)1., Comm 82.34(3)(a)1., Table Comm 82.35, Comm 82.35(3)(b)2. a. and b., (c)2. a. and b. and (d)2. b. and c., Comm 82.35(5)(a)1., Comm 82.36(4)(b)3. and (8)(a)4., Comm 82.36(3)(b)3., Table Comm 82.38-1 lines 10 to 17 and Footnote g and j, Table Comm 82.40-1 and 82.40-2, Comm 82.40(3)(b)1. b. and (d)3., Comm 82.40(5)(c) and (6)(a), Comm 82.40(7)(d)1. b., Comm 82.40(8)(j), Table Comm 82.41-1, Table Comm 82.41-2, Comm 82.41(4)(c)1. a., (f), (i) and (n) and (5)(a), (e)2. and (f)(intro.), Comm 82.50(3)(b)5., Comm 82.51, Table Comm 82.70-1 lines 2 and 10 and Footnote e, Table Comm 84.11, Comm 84.20(3)(b)2. to 8., Comm 84.20(5)(b)1. c., (n)1. a. and b., (o)1. a. and 2. b. and (p)2. c., Tables Comm 84.30-2, 84.30-5 and 84.30-6, Comm 84.30(4)(e)2., Comm 82.40(8)(b)2, Tables Comm 84.30-7, 84.30-8 and 84.30-10 and Comm 84.40(2)(a)2., (4)(b), (6)(a), (8)(c), (9)(b) and (10)(b);

repeal ss. Comm 81.01(2), Comm 81.01(199e), Comm 81.01((209e) and (209m), Comm 81.01(252e) and (258), Table Comm 81.20-10, Comm 82.21(2), Table Comm 82.21-1, Comm 82.30(6)(a)2. and (b)5., 82.31(17)(a)1. f., Comm 82.33(9)(c)1. c., Table Comm 84.10 line 8, Comm 84.30(1)(f) Note, Comm 84.30(4)(f) and (g) and Comm 84.40(12) and (16);

create ss. Comm 62.2902(1)(a)5., Comm 81.01(79m), Comm 81.01(82e) and (108e), Comm 81.01(231m), Comm 82.22, Table Comm 82.22-1, Comm 82.30(11)(h)1. g., Comm 82.32(4)(b)2. c., Comm 82.33(8)(d)6. and 7., Comm 82.34(5)(c)7., Table Comm 82.40-3e, Comm 82.40(8)(b)8., Comm 82.40(8)(d)3. b., Comm 82.41(3)(b)4. e. and Comm 84.30(5)(c)20.;

repeal and recreate ss. Comm 81.01(80), Comm 81.01(151), (152), (153) and (154), Comm 81.01(163), Comm 81.01(203), Comm 81.01(204m), Comm 82.21(b)1. b., Comm 82.30(4)(b), Comm 82.30(6)(b)4. and 5., Comm 82.31(5) and (6), Comm 82.30(11)(e)2. and 3., Comm 82.30(11)(f)2., Table Comm 82.30-2, Comm 82.31(5), Comm 82.33(7)(a), Comm 82.34(4)(b)2., Comm 82.34(14)(a)2., Comm 82.35(3)(a), Comm 82.36(11), Comm 82.40(3)(e), Comm 82.40(8)(e)2. and Comm 84.20(5)(o)3.;

renumber and amend ss. Tables Comm 81.20-10m, Comm 82.34(5)(intro.) to (d), and Comm 84.40(14) to (19); and

renumber ss. Comm 82.21(1)(d), Comm 82.21(3), Comm 82.30(4)(c) to (e), Comm 82.30(6)(a)1., 82.30(11)(h)1. g. to i., Comm 82.40(8)(d)e., Comm 84.30(4)(h) and (i) and Comm 84.40(13) to (19) relating to the design, installation or construction, inspection and maintenance of plumbing.

\*\*\*\*\*  
\*

## ANALYSIS OF PROPOSED RULES

### **1. Statutes Interpreted.**

Sections 101.02 and 145.02, Stats.

### **2. Statutory Authority.**

Sections 101.02 and 145.02, Stats.

### **3. Related Statute or Rule.**

- Section 145.13, Stats
- Chapters Comm 60 to 66, Commercial Building Code
- Chapters 20 to 25, Uniform Dwelling Code
- Chapters 81 to 87, Uniform Plumbing Code

### **4. Explanation of Agency Authority.**

Sections 101.02 and 145.02 Stats., grant the Department of Commerce general authority for protecting the health, safety and welfare of the public by establishing reasonable and effective safety standards for the design, installation or construction, inspection and maintenance of plumbing. In accordance with s.145.13, Stats., the Department is also responsible for safeguarding the waters of the state.

### **5. Summary of Proposed Rules.**

The proposed revisions to Chapters Comm 81 to 84 clarify existing rules and bring the state Uniform Plumbing Code up to date with current technology and nationally recognized standards. The proposed rules contain a number of modifications to the technical requirements within these standards, reorganization of current requirements and editorial changes.

The proposed change in Chapter Comm 62 would limit the installation of waterless toilets and waterless antiseptic cleansing provisions where used in lieu of water-based toilets and cleansing provisions.

The following is a summary of the major proposed changes to Chapters Comm 81 to 84:

- a. Allow the recycling of wastewater discharged from water closets and urinals.  
[Comm 82.34 (3) (a) 1.]
- b. Create code language to recognize alternate standards that have been used by the department. (e.g. Pressurized sewer systems and water treatment device sizing).  
[Comm 82.30 (11) (f) 2. and Comm 82.40, Table 82.40-3e]

- c. Expand the requirement for demand regeneration controls for water treatment devices to devices that discharge to municipal sewers. [Comm 82.40 (8) (j)]
- d. Use the term “manufactured home” in place of the term “mobile home” in numerous places as referenced in s.101.91 (2), Stats. [Comm 81.01 (152), (153), and (154) and Comm 82.51]
- e. Change the calculation of the load factor on drain piping so it reflects national model plumbing code requirements. [Comm 82.30 (3)]
- f. Modify the triggers for the installation of stack vents serving drain stacks from two to five or more branch intervals. [Comm 82.31 (4)(a) and 82.31 (5)]
- g. Expand and describe more fully the grease and oil treatment requirements for restaurants. [Comm 82.34 (5)]
- h. Modify the requirements for secondary roof drains so they more closely follow national standards. [Comm 82.36 (11)]
- i. Upgrade the requirements for water conserving fixtures to more closely correspond to national standards. [Comm 84.20 (3)(b)2.]

## **6. Summary of, and Comparison with, Existing or Proposed Federal Regulations.**

There are several existing federal regulations that relate to the design, installation or construction, inspection and maintenance and repair of plumbing. Some of these regulations require compliance with the 2006 editions of the International Plumbing Code (IPC), a national model code developed by the International Code Council (ICC), and the Uniform Plumbing Code (UPC), a national model code developed by the International Association of Plumbing and Mechanical Officials.

An Internet-based search of the *United States Code* (USC) found the following existing federal rules that impact plumbing. The Wisconsin Uniform Plumbing Code reflects the requirements currently contained in these federal laws.

- Assembly Bill No. 1953, Chapter 853 – The Lead Solder, Pipe and Flux Law expands Section 116875 of the Health and Safety Code as contained in USC Title 42, Chapter 6A, Subchapter XII, Part B, Section 300g-6 relating to lead plumbing to include any pipe or plumbing fitting, or fixture intended to convey or dispense water for human consumption. The law, which becomes effective January 1, 2010, passed both the Assembly and the Senate in 2006 and also revises the term “lead free.”
- USC Title 42, Chapter 6A, Subchapter XII, Part F, Section 300j-24 – Lead contamination in school drinking water outlines the testing protocol for lead contamination in drinking water from coolers and other sources at educational agencies, private nonprofit elementary or secondary schools and day care centers.

The law became effective in 1999. Currently, legislation is being proposed that would amend this section of the Safe Drinking Water Act.

- USC Title 33, Chapter 26, Subchapter IV, Section 1342 – National Pollutant Discharge Elimination System (NPDES) established Phase I of the storm water program in 1990. Nine years later, Phase II of the program was signed into law and requires smaller communities to develop and implement a comprehensive storm water management program.

An Internet-based search of the 2005 through 2008 issues of the *Federal Register* found a proposed rule about plumbing connections to manufactured homes published April 26, 2005 in Vol. 70, No. 79. Comments and an analysis have been received and the final rule will become effective October 20, 2008.

## **7. Comparison with Rules in Adjacent States.**

An Internet-based search of the four adjacent states found the following:

- The Illinois Department of Public Health administers a state-written uniform plumbing code with exceptions for cities that existed prior to Illinois statehood.
- The Iowa Department of Public Health administers the Iowa Uniform Plumbing Code that adopts the 2000 edition of the national UPC with amendments.
- The Michigan Department of Consumer and Industry Services, Bureau of Construction Codes developed the 2003 Michigan Plumbing Code that became effective December 31, 2003. Based on the IPC, the code includes state amendments.
- The Minnesota Department of Labor and Industry, Building Codes and Standards Division, administers the Minnesota Plumbing Code, a state written uniform code that was revised August 25, 2003.

## **8. Summary of Factual Data and Analytical Methodologies.**

The methodology for updating the Wisconsin Uniform Plumbing Code, chapters Comm 81 to 84 has been a review and assessment of the latest editions of the national technical standards that serve as the basis for Wisconsin code. Staff prepared a comprehensive comparison of the changes in the 2006 editions of the IPC and the national UPC to what currently is adopted in chapters Comm 81 to 84. The department's review and assessment process involved the participation of the Plumbing Advisory Code Council. The members of that Council represent the many stakeholders involved in the plumbing industry including designers, inspectors, labor and building contractors. (A listing of the Plumbing Advisory Code Council is provided at the end of this analysis.)

The department believes the national model codes reflect current societal values with respect to safeguarding people and property from hazards arising from the use of plumbing.

**9. Analysis and Supporting Documents Used to Determine Effect on Small Business or in Preparation of Economic Impact Report.**

The department used the Plumbing Advisory Code Council to gather and analyze information on potential impacts in complying with both the technical and administrative requirements of the codes. Many small businesses belong to the industry associations that sit on the advisory council. A responsibility of council members is to bring forth concerns that their respective organizations may have with the requirements including economic impact.

In addition to posting rule development and council activities on the department's web site, the department offers an Email subscription service that is available to all small businesses. This service provides Email notification of council meetings, meeting, agendas and council meeting progress reports so small businesses can follow proposed code changes.

**10. Effect on Small Business.**

The department believes the rules will not increase the effect on small businesses from what the current rules impose on them. An economic impact report is not required pursuant to s. 227.137, Stats

**11. Agency Contact Person.**

Lynita Docken, Program Manager, lynita.docken@wisconsin.gov, (608) 785-9349.

**12. Public Hearing Comments.**

A public hearing has been scheduled for July 8, 2008. The hearing record on this proposed rulemaking will remain open until July 18, 2008, to permit submittal of written comments from persons who are unable to attend the hearing or who wish to supplement testimony offered at the hearing. Written comments should be submitted to Lynita Docken at the Department of Commerce, P.O. Box 2689, Madison, WI 53701-2689, or Email at [lynita.docken@wisconsin.gov](mailto:lynita.docken@wisconsin.gov).

**Council Members and Representatives**

The proposed rules have been developed with the assistance of the Plumbing Advisory Code Council. The members of that citizen advisory council are as follows:

<u>Name</u>	<u>Representing</u>
Art Biesek	League of Wisconsin Municipalities
Thomas Boehnen	American Society of Plumbing Engineers
Patrick Casey	Plumbers' Local 75

Hallet Jenkins Milwaukee City Department of Neighborhood Services  
Gary Kowalke Wisconsin Association of Plumbing-Heating-Cooling Contractors  
Jeff Kuhn Plumbing and Mechanical Contractors of SE Wisconsin  
Rudolf Petrowitsch American Society of Sanitary Engineering  
Gene Shumann Designer  
David Viola Plumbing Manufacturers Institute  
Joseph Zoulek Wisconsin Association of Plumbing-Heating-Cooling Contractors

\*\*\*\*\*

\*

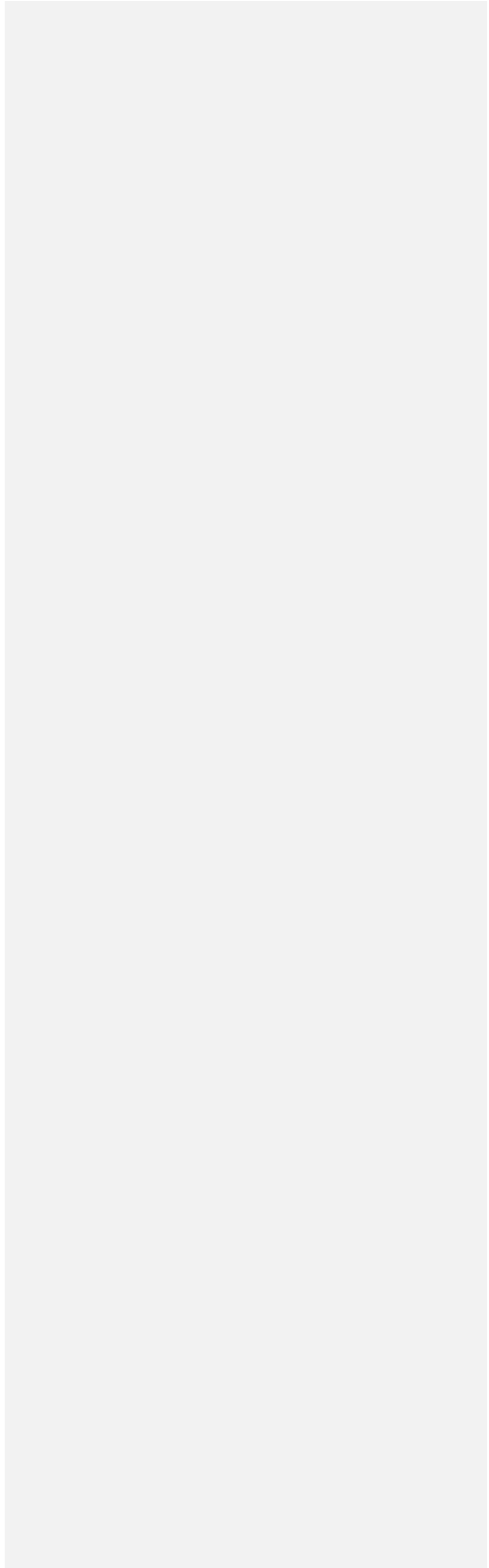

SECTION 1. Comm 62.2900 (1) is amended to read:

**Comm 62.2900 (1) PLUMBING FIXTURE ALTERNATIVES.** (a) *Water closets.* 1. Systems or devices recognized under ~~ch. Comm 91~~ ss. Comm 91.10 and 91.11 may be substituted for water closets required under IBC chapter 29.

2. Privies recognized under ch. Comm 91 may be substituted for water closets required under IBC chapter 29 in any of the following situations:

a. A building accommodating a seasonal occupancy when occupancy of the building does not extend for more than 3 of the 4 seasons.

b. A building accommodating a school or a assembly that is operated by and for members of a bona fide religious denomination in accordance with the teachings and beliefs of the denomination.

c. As approved by the department.

3. Portable restrooms recognized under ch. Comm 91 may be substituted for water closets required under IBC chapter 29 for buildings accommodating events or temporary occupancies not exceeding 12 consecutive days or as approved by the department.

(b) Lavatories. Waterless antiseptic cleansing provisions may be substituted for lavatories required under IBC chapter 29 where systems or devices under par. (a) 2. are substituted for water closets. Where water-based water closets or urinals are used, water-based lavatories shall be provided in numbers to accommodate the number of people served by the water closets and urinals.

SECTION 2. Comm 62.2902 (1) (a) 5. is created to read:

**Comm 62.2902 (1) (a) 5.** Service sinks may be omitted for any occupancy where privies have been substituted for water closets under s. Comm 62.2900 (1) (a) 2.

SECTION 3. Comm 81.01 (5) is amended to read:

**Comm 81.01 (5)** “Air-break” means a piping arrangement for a drain system where the wastes from a fixture, appliance, appurtenance or device discharge by means of indirect or local waste piping terminating in a receptor at a point below the flood level rim of the receptor and above the ~~inlet~~ outlet of the trap serving the receptor.

SECTION 4. Comm 81.01 (20), (67e) and (67m) are repealed.



SECTION 5. Comm 81.01 (79) is amended to read:

**Comm 81.01 (79)** “Double check backflow prevention assembly” means a type of cross connection control ~~device~~ assembly which is composed of 2 independently acting check valves internally force-loaded to a normally closed position, tightly closing shut-off valves located at each end of the assembly and fitted with test cocks. ~~The terms “backflow preventer, double check valve type” or “DCV” have~~ The term “double check valve backflow preventer” has the same meaning as double check backflow prevention assembly.

SECTION 6. Comm 81.01 (79m) is created to read:

**Comm 81.01 (79m)** “Double check fire protection backflow prevention assembly” means an assembly serving a fire protection system and consisting of two independently acting check valves, internally forced loaded to a normally closed position, two tightly closing shut-off valves, and properly located test cocks. The term “double check valve backflow preventer for fire protection systems” has the same meaning as double check fire protection backflow prevention assembly.

SECTION 7. Comm 81.01 (80) is repealed and created to read:

**Comm 81.01 (80)** “Double check detector fire protection backflow preventer-assembly” means an assembly serving a fire protection system and consisting of two independently acting check valves, internally forced loaded to a normally closed position, two tightly closing shut-off valves, and properly located test cocks which also includes a parallel flow meter to indicate leakage or unauthorized use of water downstream of the assembly.

SECTION 8. Comm 81.01 (82e) and (108e) are created to read:

**Comm 81.01 (82e)** “Dual check backflow preventer wall hydrant-freeze resistant type” means a type of hose bibb that provides protection of the potable water supply from contamination due to backsiphonage or backpressure without damage to the device due to freezing, and is field testable to verify protection under the high hazard conditions present at a hose threaded outlet.

**(108e)** “Freeze resistant sanitary yard hydrant” means a type of device serving as a hose bibb that has design features that minimize the risk of freezing, prevent groundwater contamination and provide backflow protection. The term “freeze resistant sanitary yard hydrant with backflow protection” has the same meaning as freeze resistant sanitary yard hydrant.

SECTION 9. Comm 81.01 (115), (120) and (147) are amended to read:

**Comm 81.01 (115)** “Hand-held shower” means a ~~type of plumbing fixture that includes a cross connection control device, a~~ hose and a hand-held discharge piece such as a shower head or spray connecting to a fixture fitting.

**(120)** “High hazard” means a situation where the water supply system could be contaminated with a toxic substance or solution so as to ~~alter the characteristics of the water making~~ make the water unsuitable for the designated use.

**(147)** “Low hazard” means a situation where the water supply system could be contaminated with a nontoxic substance or solution so as to ~~alter the characteristics of the water making~~ make the water unsuitable for the designated use.

SECTION 10. Comm 81.01 (151), (152), (153) and (154) are repealed and recreated to read:

**Comm 81.01 (151)** “Manufactured home” has the meaning specified under s. 101.91 (2), Stats.

**Note:** Section 101.91 (2), Stats. reads: “Manufactured home” means any of the following:

(am) A structure that is designed to be used as a dwelling with or without a permanent foundation and that is certified by the federal department of housing and urban development as complying with the standards established under 42 USC 5401 to 5425.

(c). A mobile home, unless a mobile home is specifically excluded under the applicable statute.

**(152)** “Manufactured home drain connector” means the pipe that joins the drain piping for a manufactured home to the building sewer.

**(153)** “Manufactured home community” has the meaning specified under s. 101.91 (5m), Stats.

**Note:** Section 101.91 (5m), Stats. reads: “Manufactured home community” means any plot or plots of ground upon which 3 or more manufactured homes that are occupied for dwelling or sleeping purposes are located. “Manufactured home community” does not include a farm where the occupants of the manufactured homes are the father, mother, son, daughter, brother or sister of the farm owner or operator or where the occupants of the manufactured homes work on the farm.

**(154)** “Mechanical joint” means a connection between pipes, fittings or pipes and fittings by means of a device, coupling, fitting or adapter where compression is applied around the center line of the pieces being joined, but which is not caulked, threaded, soldered, solvent cemented, brazed or welded.

SECTION 11. Comm 81.01 (156) is amended to read:

**Comm 81.01 (156)** “Multipurpose piping system” means a ~~type of~~ water distribution system conveying ~~potable~~ water to plumbing fixtures and appliances and automatic fire sprinklers with the intention of serving both domestic ~~water needs~~ and fire protection needs ~~within an one- or 2-family dwelling or manufactured dwelling.~~

SECTION 12. Comm 81.01 (163) is repealed and recreated to read:

**Comm 81.01 (163)** “Nontoxic” means a substance in the diluted form that meets one of the following requirements:

(a) Is listed by the National Sanitation Foundation (NSF) as meeting the NSF evaluation criteria for nonfood compounds.

(b) Is acceptable to the United States Food and Drug Administration (FDA) Title 21 Section 175.300 of the Federal Regulation on Food Additives.

(c) Is acceptable for contact with potable water or is deemed non-toxic by a third party certification that is acceptable to the department.

(d) Is deemed non-toxic by the department.

SECTION 13. Comm 81.01 (189) is amended to read:

**Comm 81.01 (189)** “Pressure vacuum breaker assembly” means a type of cross connection control ~~device~~ assembly which consists of an independently operating internally loaded check valve and an independently operating loaded air inlet located on the discharge side of the check valve, a tightly closing shut-off valve located at each end of the assembly, and test cocks. The term “PVB pressure vacuum breaker” has the same meaning as pressure vacuum breaker assembly.

SECTION 14. Comm 81.01 (199e) is repealed.

SECTION 15. Comm 81.01 (203) is repealed and recreated to read:

**Comm 81.01 (203)** “Reduced pressure detector fire protection backflow prevention assembly” means a type of reduced pressure principle type backflow preventer serving a fire protection system and which includes a parallel flow meter to indicate leakage or unauthorized use of water downstream of the assembly.

SECTION 16. Comm 81.01 (204) is amended to read:

**Comm 81.01 (204)** “Reduced pressure principle backflow preventer” means a type of cross connection control ~~device~~ assembly which contains 2 independently acting check valves, separated by an intermediate chamber or zone in which there is a hydraulically operated means for venting to atmosphere, and includes 2 shut-off valves and 4 test cocks. ~~The term “RP detector” has the same meaning as reduced pressure detector backflow preventer.~~

SECTION 17. Comm 81.01 (204m) is created to read:

**Comm 81.01 (204m)** “Reduced Pressure Fire Protection Principle Backflow Preventer” means an assembly serving a fire protection system and consisting of two independently-acting check valves, internally force loaded to a normally closed position, and separated by an intermediate chamber or zone in which there is an hydraulically operated relief means of venting to atmosphere, internally forced loaded to a normally open position. The term “reduced pressure principle backflow preventer for fire protection systems” has the same meaning as reduced pressure fire protection principle backflow preventer.

SECTION 18. Comm 81.01 (209e) and (209m) are repealed.

SECTION 19. Comm 81.01 (231m) is created to read:

**Comm 81.01 (231m)** “Spill Resistant Vacuum Breaker” means a cross connection control device consisting of one check valve force loaded closed, an air inlet force loaded open to atmosphere downstream of the check valve, two shutoff valves and two test cocks.

SECTION 20. Comm 81.01 (234) is amended to read:

**Comm 81.01 (234)** “Stack vent” means a vent extending from the ~~top of a drain stack of at least two branch intervals.~~ highest horizontal drain connected to a stack.

SECTION 21. Comm 81.01 (252e) and (258) are repealed.

SECTION 22. Comm 81.01 (269) and (288) are amended to read:

**Comm 81.01 (269)** “Vent stack” means a vertical vent pipe that provides air for a drain stack of ~~two~~ 5 or more branch intervals.

**Comm 81.01 (288)** “Wet vent” means that portion of a vent pipe ~~which that~~ receives the discharge of wastes from ~~other than water closets, urinals or other fixture which discharge like sewage or fecal matter~~ other fixtures.

SECTION 23. Comm 81.20 (1) is amended to read:

**Comm 81.20 (1) (a)** Pursuant to s. 227.21 (2), Stats., the attorney general ~~and the revisor of statutes have~~ has consented to the incorporation by reference of the standards listed in sub. (3).

(b) The codes and standards that are referenced in this chapter, and any additional codes and standards that are subsequently referenced in those codes and standards, shall apply to the prescribed extent of each such reference, except as modified by this chapter.

**Note:** Copies of the adopted standards are on file in the offices of the department, ~~the secretary of state~~ and the legislative reference bureau. Copies of the standards may be purchased through the respective organizations listed in Tables 81.20-1 to 81.20-13.

SECTION 24. Tables 81.20-1 to 81.20-9 are amended to read:

**Table 81.20-1**

<b>AHAM</b>	<b>Association of Home Appliance Manufacturers 20 North Wacker Drive Chicago, Illinois 60606 <u>Phone: 202-872-5955</u> <u>Web page: www.aham.org</u></b>
<b>Standard Reference Number</b>	<b>Title</b>
DW-1- <u>922005</u>	Household Electric Dishwashers

**Table 81.20-2**

<b>ANSI</b>	<b>American National Standards Institute, Inc. 1430 Broadway New York, New York 10018 Phone: 212-642-4900 Web page: <a href="http://www.ansi.org">www.ansi.org</a></b>
<b>Standard Reference Number</b>	<b>Title</b>
1. <del>Z21.22a-9099</del> (R 2004)	<del>Relief Valves and Automatic Gas Shutoff Devices for Hot Water Supply Systems</del>
2. <del>Z21.61-83</del>	<del>Gas-Fired Toilets</del>
2. <del>Z21.22a-2000</del>	<del>Relief Valves for Hot Water Supply Systems (Addenda 2000)</del>
3. <del>Z124.1-95</del>	<del>Plastic Bathtub Units</del>
3. <del>Z21.22b-2001</del>	<del>Relief Valves for Hot Water Supply Systems (Addenda 2001)</del>
4. <del>Z124.1,2-95</del> 2005	<del>Plastic Shower Receptors and Shower Stalls</del>
5. <del>Z124.3-95</del> 2005	<del>Plastic Lavatories</del>
6. <del>Z124.4-96</del> 2006	<del>Plastic Water Closet Bowls and Tanks</del>
7. <del>Z124.6-97</del>	<del>Plastic Sinks</del>
8. <del>Z124.9-94</del> 2004	<del>Plastic Urinal Fixtures, Plastic Urinal, American National Standard for</del>

**Table 81.20-3**

<b>ARI</b>	<b>Air-Conditioning and Refrigeration Institute 1815 North Fort Myer Drive Arlington, Virginia 22209 Phone: 703-524-8800 Web page: <a href="http://www.ari.org">www.ari.org</a></b>
<b>Standard Reference Number</b>	<b>Title</b>
ARI-1010-942002	Self-Contained Mechanically-Refrigerated Drinking-Water Coolers

Table 81.20-3e

ASME	
<b>American Society of Mechanical Engineers</b> <b>345 East 47<sup>th</sup> Street</b> <b>New York, New York 10017</b> <b>Phone: (800) <del>THE</del>-ASME, 800-843-2763</b> <b>Web page: <a href="http://www.infocentral@asme.org">www.infocentral@asme.org</a></b>	
Standard Reference Number	Title
1. A112.1.2-94 <del>(R1998)</del> 2004	Air Gaps in Plumbing Systems ( <u>For Plumbing Fixtures and Water-Connected Receptors</u> )
1e. A112.1.3-00	Air-gap Fittings for Use with Plumbing Fixtures, Appliances, and Appurtenances
2. A112.6.1M-97 <del>(R2002)</del>	Floor-Affixed Supports for Off-the-Floor Plumbing Fixtures for Public Use
<u>2m. A112.6.3-2001</u>	<u>Floor and Trench Drains</u>
3. A112.14.1-75 <del>(R1998)</del> 03 <del>(R2008)</del>	Backwater Valves
4. A112.18.1M-962005	Plumbing <del>Fixture Fittings</del> <u>Supply Fittings</u>
5. A112.19.1M-94 <u>(R 2004)</u>	Enameled Cast Iron Plumbing Fixtures
<u>5m. A112.19.1M-1994</u>	<u>Errata November 1994 to Enameled Cast Iron Plumbing Fixtures</u>
6. A112.19.1M-1994	<u>Supplement 1-1998 to Enameled Cast Iron Plumbing Fixtures</u>
7. A112.19.1M-1994	<u>Supplement 2-2000 to Enameled Cast Iron Plumbing Fixtures</u>
<del>6, 8.</del> A112.19.2M-952003	<u>Vitreous China Plumbing Fixtures and Hydraulic Requirements for Water Closets and Urinals</u>
<del>7, 9.</del> A112.19.3M-87 <del>(R1996)</del> 2000 (R 2004)	Stainless Steel Plumbing Fixtures (Designed for Residential Use)
10. A112.19.3-2002	<u>Supplement 1.-2002 to Stainless Steel Plumbing Fixtures (Designed for Residential Use)</u>
<del>8, 11.</del> A112.19.4-94 <u>(R 2004)</u>	Porcelain Enameled Formed Steel Plumbing Fixtures
<del>9, 12.</del> A112.19.5-79 <del>(R1998)</del> 2005	Trim for Water-Closet Bowls, Tanks, and Urinals ( <del>Dimensional Standards</del> )
10. A112.19.6-95	<del>Hydraulic Performance Requirements for Water Closets and Urinals</del>
11. A112.21.1M-91	<del>Floor Drains</del>
12. A112.21.2M-83	<del>Roof Drains</del>
13. B1.20.1-83 <del>(R1992)</del> <u>2006)</u>	Pipe Threads, General Purpose (Inch)
14. B16.1-89 <u>2005</u>	Cast Iron Pipe Flanges and Flanged Fittings ( <u>Classes 25, 125, and 250</u> )
15. B16.3-92 <u>1998 (R 2006)</u>	Malleable Iron Threaded Fittings ( <u>Classes 150 and 300</u> )
16. B16.4-92 <u>2006</u>	Gray Iron Threaded Fittings (Classes 125 and 250)
17. B16.5 <del>a-98</del> <u>2003</u>	Pipe Flanges and Flanged Fittings NPS ½ Through NPS 24 (and addenda)
18. B16.9-93 <u>2003</u>	Factory-Made Wrought <del>Steel</del> <u>Buttwelding Fittings</u>

19. B16.11- <del>96</del> 2005	Forged Fittings, Socket – Welding and Threaded
20. B16.12- <del>94</del> 1998 (R 2006)	Cast Iron Threaded Drainage Fittings
21. B16.15-85 (R 1994)	Cast Bronze Threaded Fittings, Classes 125 and 250
22. B16.18-84 (R 1994)	Cast Copper Alloy Solder Joint Pressure Fittings
<del>2001 (R 2005)</del>	
23. B16.22- <del>95</del> 2001 (R 2005)	Wrought Copper and Copper Alloy Solder – Joint Pressure Fittings
24. B16.23- <del>92</del> 2002 (R2006)	Cast Copper Alloy Solder Joint Drainage Fittings – DWV
25. B16.24- <del>94</del> 2001	Cast Copper Alloy Pipe Flanges and Flanged Fittings, Class 150, 300, 400, 600, 900, 1500 and 2500
26. B16.26- <del>88</del> 2006	Cast Copper Alloy Fittings for Flared Copper Tubes
27. B16.28-94	Wrought Steel Buttwelding Short Radius Elbows and Returns
28. B16.29- <del>94</del> 2001	Wrought Copper and Wrought Copper Alloy Solder Joint Drainage Fittings – DWV
29. B16.42-87 (R1997)	Ductile Iron Pipe Flanges and Flanged Fittings
<del>1998 (R 2006)</del>	
30. B16.45-87 (R1997)	Cast Iron Fittings for Sovent <sup>®</sup> Drainage Systems
<del>1998 (R 2006)</del>	
31. B36.19M-85	Stainless Steel Pipe
<del>(R1994)2004</del>	

**Table 81.20-4**

<b>ASSE</b>	<b>American Society of Sanitary Engineering P.O. Box 9712 Bay Village, Ohio 4414 Phone: 440-835-3040 Web page: <a href="http://www.asse-plumbing.org">www.asse-plumbing.org</a></b>
<b>Standard Reference Number</b>	<b>Title</b>
1. <del>1001-90</del> 2002	<del>Pipe Applied</del> Atmospheric Type Vacuum Breakers
2. 1002- <del>86</del> 1999	<del>Anti-siphon Fill Valves (Ballcocks) for Gravity Water Closet Flush Tank Tanks Ball Cocks</del>
3. 1003- <del>95</del> 2001	Water Pressure Reducing Valves
4. 1004-1990	Commercial Dishwashing Machines
5. <del>1005-86</del>	<del>Water Heater Drain Valves</del>
6. <del>5. 1006-1989</del>	Residential Use (Household) Dishwashers
7. <del>6. 1007-92</del> 1992	Home Laundry Equipment
8. <del>7. 1008-89</del> 2006	<del>Household Plumbing Aspects of Residential</del> Food Waste Disposer Units
9. <del>8. 1009-90</del> 1990	Commercial Food Waste Grinder Units
10. <del>9. 1010-96</del> 2004	Water Hammer Arresters
11. <del>10. 1011-95</del> 2004	Hose Connection Vacuum Breakers
12. <del>11. 1012-93</del> 2002	Backflow <del>Preventers</del> <u>Preventer</u> with Intermediate Atmospheric Vent
13. <del>12. 1013-99</del> 2005	Reduced Pressure <u>Principle</u> Backflow <del>Preventer</del> <u>Preventers</u> and Reduced Pressure <del>Detector</del> -Fire Protection Principle Backflow Preventers



<del>14.</del> <u>13.</u> 1014-902005	<u>Backflow Prevention Devices for Hand-Held Showers</u>
<del>15.</del> <u>14.</u> 1015-992005	<u>Double Check Backflow Prevention Assemblies and Double Check Fire Protection Backflow Prevention Assemblies</u>
<del>15e.</del> <u>15.</u> 1016-962005	<u>Automatic Compensating Valves for Individual Showers and Tub/Shower Combinations</u> <del>Thermostatic, Pressure Balancing, and Combination Pressure Balancing and Thermostatic Control Valves for Individual Fixture Fittings</del>
<u>15m.</u> 1017-2003	<u>Temperature Actuated Mixing Valves for Hot Water Distribution Systems</u>
<u>16.</u> 1018-882001	<u>Trap Seal Primer Valves – Potable – Water Supply Fed-Supplied</u>
<u>17.</u> 1019-972004	<u>Vacuum Breaker Wall Hydrants, Freeze Resistant Automatic Draining Type</u>
<u>18.</u> 1020-892004	<u>Pressure Vacuum Breaker Assembly</u>
<u>18m.</u> 1021-2001	<u>Drain Air Gaps for Domestic Dishwasher Applications</u>
<del>18e.</del> <u>19.</u> 1022-962003	<u>Backflow Preventer for Carbonated Beverage Dispensing Equipment Machines</u>
<del>19.</del> <u>20.</u> 1023-791979	<u>Hot Water Dispensers, Household Storage Type, Electrical</u>
<u>20.</u> 1025-78	<u>Diverters for Plumbing Faucets with Hose Spray, Anti-Siphon Type, Residential Applications</u>
<del>21.</del> <u>20m.</u> 1035-952002	<u>Laboratory Faucet Backflow Preventers</u>
<del>22.</del> <u>21.</u> 1037-901990	<u>Pressurized Flushing Devices (Flushometers) for Plumbing Fixtures</u>
<del>23.</del> <u>22.</u> 1047-992005	<u>Reduced Pressure Detector Fire Protection Backflow Preventer Prevention Assemblies</u>
<u>24.</u> <del>23.</del> 1048-992005	<u>Double Check Detector Fire Protection Backflow Prevention Assemblies</u>
<del>24.</del> 1052-942004	<u>Hose Connection Backflow Preventers</u>
<u>24e.</u> 1053-2005	<u>Dual Check Backflow Preventer Wall Hydrant Freeze Resistant Type</u>
<del>25e.</del> <u>25.</u> 1055-971997	<u>Chemical Dispensing Systems</u>
<u>26.</u> 1056-952001	<u>Spill Resistant Back Siphonage Vacuum Breakers</u>
<u>26e.</u> 1066-971997	<u>Individual Pressure Balancing In-Line Valves for Individual Fixture Fittings</u>
<u>27.</u> 5013-2004 <sup>a</sup>	<u>Minimum Performance Requirements for Testing Reduced Pressure Principle Backflow Preventers (RP) and Reduced Pressure Principle Fire Protection Backflow Preventers (RPF)</u>
<u>28.</u> 5015-2004 <sup>a</sup>	<u>Minimum Performance Requirements for Testing Double Check Backflow Prevention Assemblies (DC) and Double Check Fire Protection Backflow Prevention Assemblies (DCF)</u>
<u>29.</u> 5020-2004 <sup>a</sup>	<u>Minimum Performance Requirements for Testing a Pressure Vacuum Breaker Assembly</u>
<u>30.</u> 5047-2004 <sup>a</sup>	<u>Minimum Performance Requirements for Testing Reduced Pressure Detector Fire Protection Backflow Prevention Assemblies (RPDF)</u>
<u>31.</u> 5048-2004 <sup>a</sup>	<u>Minimum Performance Requirements for Testing Double Check Detector Fire Protection Backflow Prevention Assemblies (DCDF)</u>
<u>32.</u> 5056-2004 <sup>a</sup>	<u>Minimum Performance Requirements for Testing Spill</u>

Resistant Vacuum Breaker

<sup>a</sup> Standard is contained in the ASSE5000 Series of standards.

**Table 81.20-5**

~~American Society for Testing and Materials~~ **ASTM  
International**  
100 Barr Harbor Drive  
West Conshohocken, Pennsylvania 19428-2959  
Phone: (610) 832-9585  
Web page: [www.astm.org](http://www.astm.org)

Standard Reference Number	Title
1. <del>A53-9702</del>	Pipe, Steel, Black and Hot--Dipped, Zinc-Coated Welded and Seamless, Standard Specification for
2. <del>A74-9606</del>	Cast Iron Soil Pipe and Fittings, Standard Specification for
3. <del>A123/A123M-97a02</del>	Zinc (Hot-Galvanized) Coatings on Products, Specification for
4. <del>A270-95a03a</del>	Seamless and Welded Austenitic Stainless Steel Sanitary Tubing, Specification for
5. <del>A377-95-03</del>	<del>Ductile Iron Pressure Pipe, Standard Index of Specifications for</del>
6. <del>5. A403/A403M-97a07</del>	Wrought Austenitic Stainless Steel Piping Fittings, Specification for
7. <del>6. A450/A450M-9604a</del>	Carbon, Ferritic Alloy, and Austenitic Alloy Steel Tubes
7e. <del>7. A888-9807a</del>	Hubless Cast Iron Soil Pipe and Fittings for Sanitary and Storm Drain, Waste, and Vent Pipe Applications, Specifications for
8. <del>B32-9604</del>	Solder Metal
9. <del>B42-9 02<sup>E1</sup></del>	Pipe, Seamless Copper, Standard Sizes
10. <del>B43-9698</del>	Seamless Red Brass Pipe, Standard Sizes, Specification for
11. <del>B88/B88M-9603</del>	<del>Water, Seamless, Copper Water Tube, Specification for</del>
11m. <del>B88M-05</del>	<u>Seamless Copper Water Tube (Metric), Specification for</u>
12. <del>B152/B152M-97a06a</del>	Copper Sheet, Strip, Plate, and Rolled Bar, Specification for
13. <del>B251/B251M-9702<sup>E1</sup></del>	Tube, Wrought Seamless Copper and Copper
14. <del>B302-9702</del>	Threadless Copper Pipe, Specification for
15. <del>B306-9602</del>	<del>Standard Specifications for Copper Drainage Tube (DWV),</del> <u>Standard Specifications for</u>
15s. <del>15m. B828-9802</del>	Making Capillary Joints by Soldering of Copper and Copper Alloy Tube and Fittings, Practice for
17. <del>16. C14/C14M-9507</del>	<u>Nonreinforced Concrete Sewer, Storm Drain, and Culvert Pipe,</u> Specification for
17. <del>C14M-9507</del>	<u>Nonreinforced Concrete Sewer, Storm Drain, and Culvert Pipe (Metric), Specification for</u>
18. <del>C33-9703</del>	Concrete Aggregates, <u>Specification for</u>
19. <del>C76-9807</del>	<u>Reinforced Concrete Culvert, Storm Drain, and Sewer Pipe,</u> <del>Reinforced Concrete Specification for</del>

20. C76M-9707 Reinforced Concrete Culvert, Storm Drain, and ~~Culvert Sewer~~ Pipe (Metric), Specifications for
21. C425-9704 ~~Compression Joints for Vitrified Clay Pipe and Fittings for Vitrified Compression Joints~~, Specification for
22. C443/C443M-9407 Specification for Joints for Circular Concrete Sewer and Culvert Pipe, Using Rubber Gaskets
- 22e. C443M-07 ~~Specification for Joints for Circular Concrete Sewer and Culvert Pipe, Using Rubber Gaskets (Metric)~~
- 22e. 22m. C507/C507M-95a Reinforced Concrete Elliptical Culvert, Storm Drain and Sewer, (Metric) Specifications for
23. C564-9703a Rubber Gaskets for Cast Iron Soil Pipe and Fittings, Specification for
24. C700-9707 Vitrified Clay Pipe, Extra Strength, Standard Strength, and Perforated, Specification for
- 24e. C877/C877M-94 External Sealing Bands for ~~Noncircular Concrete Sewer, Storm Drain, and Culvert~~ Pipe, Manholes and Precast Box Sections, (Metric), Standard Specifications for
- 24h. C923-9807 Resilient Connectors Between Reinforced Concrete Manhole Structures, Pipes, and Laterals, Specification for
- 24m. C990/C990M-96 Joints for Concrete Pipe, Manholes, Precast Box Sections Using Preformed Flexible Joint Sealants, Specifications for
- 24s. C1306-9505a Hydrostatic Pressure Resistance of a Liquid-Applied Waterproofing Membrane, Standard Test Method for
25. D1527-96a99 (R 2005) Acrylonitrile-Butadiene-Styrene (ABS), Schedules 40 and 80
26. D1785-96b06 Poly (Vinyl Chloride) (PVC) Plastic Pipe, Schedules 40, 80 and 120, Specification for
27. D2104-9603 Standard Specifications for Polyethylene (PE) Plastic Pipe, Schedule 40
28. D2235-96a04 Standard Specifications for Solvent Cement for Acrylonitrile-Butadiene-Styrene (ABS) Plastic Pipe and Fittings
29. D2239-96a03 Polyethylene (PE) Plastic Pipe (SIDR-PR) Based on Controlled Inside Diameter, Specification for
30. D2241-96b05 Standard Specification for Poly (Vinyl Chloride) (PVC) Plastic Pipe (SDR - Series)
31. D2282-96a99 (R 2005) Acrylonitrile-Butadiene-Styrene (ABS) Plastic Pipe (SDR - PR), Specification for
32. D2321-8905 Underground Installation of Thermoplastic Pipe for Sewers and Other Gravity-Flow Applications, Practice for
33. D2447-9503 Polyethylene (PE) Plastic Pipe, Schedules 40 and 80, Based on Outside Diameter, Specification for
34. D2464-96a06 Threaded Poly (Vinyl Chloride) (PVC) Plastic Pipe Fittings, Schedule 80, Specification for
35. D2466-9706 Poly (Vinyl Chloride) (PVC) Plastic Pipe Fittings, Schedule 40, Specification for
36. D2467-96a06 ~~Socket Type~~ Poly (Vinyl Chloride) (PVC) Plastic Pipe Fittings, Schedule 80, Specification for
37. D2468-96a Acrylonitrile-Butadiene-Styrene (ABS), Plastic Pipe Fittings, Schedule 40, Specification for

38. ~~D2564-96a~~04<sup>E1</sup> Solvent Cements for Poly (Vinyl Chloride) (PVC) Plastic Systems, Specification for
39. ~~D2609-97~~02 Plastic Insert Fittings for Polyethylene (PE) Plastic Pipe, Specification for
40. ~~D2657-97~~07 Heat Fusion Joining of Polyolefin Pipe and Fittings, Standard Practice of
41. ~~D2661-97a~~06 Acrylonitrile-Butadiene-Styrene (ABS) Schedule 40 Plastic Drain, Waste, and Vent Pipe and Fittings, Specification for
42. ~~D2662-96a~~ ~~Polybutylene (PB) Plastic Pipe (SDR-PR), Based on Controlled Inside Diameter, Specification for~~
43. ~~D2665-97a~~07 Poly (Vinyl Chloride) (PVC) Plastic Drain, Waste, and Vent Pipe and Fittings, Specification for
46. ~~D2680-95a~~01 Acrylonitrile-Butadiene-Styrene (ABS) and Poly (Vinyl Chloride) (PVC) Composite Sewer Piping, Specification for
47. ~~D2683-98~~04 Socket-Type Polyethylene Fittings for Outside Diameter-Controlled Polyethylene Pipe and Tubing, Specification for
48. ~~D2729-96a~~03 Poly (Vinyl Chloride) (PVC) Sewer Pipe and Fittings, Specification for
49. ~~D2737-96a~~03 Polyethylene (PE) Plastic Tubing, Specification for
50. ~~D2751-96a~~05 Acrylonitrile-Butadiene-Styrene (ABS) Sewer Pipe and Fittings, Specification for
51. ~~D2774-94~~04<sup>E1</sup> Underground Installation of Thermoplastic Pressure Piping, Standard Practice for
52. ~~D2846/D2846M-97~~06 Chlorinated Poly (Vinyl Chloride) (CPVC) Plastic Hot- and Cold-Water Distribution Systems, Specification for
53. ~~D2852-95~~ Styrene-Rubber (SR) Plastic Drain Pipe and Fittings, Specification for
54. ~~D2855-96~~ Making Solvent-Cemented Joints with Poly (Vinyl Chloride) (PVC) Pipe and Fittings, Practice for
55. ~~D3000-95a~~ ~~Polybutylene (PB) Plastic Pipe (SDR-PR) Based on Outside Diameter, Specification for~~
56. ~~55.~~ D3034-9706 Type PSM Poly (Vinyl Chloride) (PVC) Sewer Pipe and Fittings, Specification for
57. ~~56.~~ D3035-9506 Polyethylene (PE) Plastic Pipe (SDR-PR) Based on Controlled Outside Diameter, Specification for
- 57s. ~~57.~~ D3138-9504 Solvent Cements for Transition Joints Between Acrylonitrile-Butadiene-Styrene (ABS) and Poly(Vinyl Chloride) (PVC) Non-Pressure Piping Components, Specifications for
58. ~~D3139-96a~~ ~~Joints for Plastic Pressure Pipes Using Flexible Elastomeric Seals, Specification for~~
59. ~~D3140-90~~ Flaring Polyolefin Pipe and Tubing, Practice for
60. ~~D3212-96a~~ (R 2003) Joints for Drain and Sewer Plastic Pipes Using Flexible Elastomeric Seals, Specification for
61. ~~D3261-97~~03 Butt Heat Fusion Polyethylene (PE) Plastic Fittings for Polyethylene (PE) Plastic Pipe and Tubing, Specification for
62. ~~D3309-96a~~(R 2002) ~~Polybutylene (PB) Plastic Hot and Cold Water Distribution Systems, Specification for~~
63. ~~62.~~ D3311-9406a Drain, Waste, and Vent (DWV) Plastic Fittings Patterns, Specification for

<del>64.</del> <u>63.</u> D4068- <del>9601</del>	Chlorinated Polyethylene (CPE) Sheeting for Concealed Water-Containment Membrane, Standard Test Method for
<del>65.</del> <u>64.</u> D4491- <del>89</del> <u>99a</u> (R 2004)	Water Permeability of Geotextile by Permittivity, Standard Test Method for
<del>66.</del> <u>65.</u> D4533- <del>9404</del>	Trapezoid Tearing Strength of Geotextiles, Standard Test Method for
<del>67.</del> <u>66.</u> D4632-91 (R 2003)	Grab Breaking Load and Elongation of Geotextiles, Standard Test Method for
<del>68.</del> <u>67.</u> D4751- <del>8704</del>	Determining the Apparent Opening Size of a Geotextile, Standard Test Method for
<del>69.</del> <u>68.</u> D4833- <del>8800</del> <sup>E1</sup>	Index Puncture Resistance of Geotextile, Geomembranes, and Related Products, Standard Test Methods for
<del>70.</del> <u>69.</u> F402- <del>9305</del>	Safe Handling of Solvent Cements, Primers and Cleaners Used for Joining Thermoplastic Pipe and Fittings, Practice for
<del>71.</del> <u>70.</u> F405- <del>9705</del>	Corrugated Polyethylene (PE) Tubing and Fittings, Specification for
<del>72.</del> <u>71.</u> F409- <del>9702</del>	Thermoplastic Accessible and Replaceable Plastic Tube and Tubular Fittings, Specification for
<del>73.</del> <u>72.</u> F437- <del>96a06</del>	Threaded Chlorinated Poly (Vinyl Chloride) (CPVC) Plastic Pipe Fittings, Schedule 80, Specification for
<del>74.</del> <u>73.</u> F438- <del>9704</del>	Socket-Type Chlorinated Poly (Vinyl Chloride) (CPVC) Plastic Pipe Fittings, Schedule 40, Specification for
<del>75.</del> <u>74.</u> F439- <del>9706</del>	Socket-Type Chlorinated Poly (Vinyl Chloride) (CPVC) Plastic Pipe Fittings, Schedule 80, Specification for
<del>76.</del> <u>75.</u> F441/F441M- <del>9702</del>	Chlorinated Poly (Vinyl Chloride) (CPVC) Plastic Pipe, Schedules 40 and 80, Specification for
<del>77.</del> <u>76.</u> F442/F442M- <del>9799</del> (R 2005)	Chlorinated Poly (Vinyl Chloride) (CPVC) Plastic Pipe (SDR-PR), Specification for
<del>78.</del> <u>77.</u> F477- <del>96a07</del>	Elastomeric Seals (Gaskets) for Joining Plastic Pipe, Specification for
<del>78e.</del> <u>78.</u> F492- <del>9595</del>	Propylene and Polypropylene (PP) Plastic-Lined Ferrous Metal Pipe Fittings
<del>79.</del> F493- <del>9704</del>	Solvent Cements for Chlorinated Poly (Vinyl Chloride) (CPVC) Plastic Pipe and Fittings, Specification for
<del>80.</del> F628- <del>97a06</del> <sup>E1</sup>	Acrylonitrile-Butadiene-Styrene (ABS) Schedule 40 Plastic Drain, Waste, and Vent Pipe with a Cellular Core, Specification for
<del>81.</del> F656- <del>96a02</del>	Primers for Use in Solvent Cement Joints of Poly (Vinyl Chloride) (PVC) Plastic Pipe and Fittings, Specification for
<del>81e.</del> F679- <del>9506a</del>	Poly (Vinyl Chloride) (PVC) Large-Diameter Plastic Gravity Sewer Pipe and Fittings
<del>81m.</del> F789-95a	Type PS-46 and <del>Type PS-115 PVC</del> <u>Poly(Vinyl Chloride)(PVC)</u> Plastic Gravity Flow Sewer Pipe and Fittings
<del>81s.</del> F794- <del>9703</del>	Poly (Vinyl Chloride) (PVC) Profile Gravity Sewer Pipe and Fittings Based on Controlled Inside Diameter
<del>82.</del> F810- <del>9307</del>	Smoothwall Polyethylene (PE) Pipe for Use in Drainage and Waste Disposal Absorption Fields, Specification for
<del>83.</del> F845-96	<del>Plastic Insert Fittings for Polybutylene (PB) Tubing, Specification for</del>

84. F876- <del>9706</del>	Crosslinked Polyethylene (PEX) Tubing, Specification for
85. F877- <del>97a07</del>	Crosslinked Polyethylene (PEX) Plastic Hot- and Cold-Water Distribution Systems, Specification for
86. F891- <del>9704</del>	Coextruded Poly (Vinyl Chloride) (PVC) Plastic Pipe With a Cellular Core, Specification for
87. F949- <del>96a06a</del>	Poly (Vinyl Chloride) (PVC) Corrugated Sewer Pipe With a Smooth Interior and Fittings
88. F1281- <del>9807</del>	Crosslinked Polyethylene / Aluminum / Crosslinked Polyethylene (PEX-AL-PEX) Pressure Pipe
89. F1282- <del>9706</del>	Polyethylene / Aluminum / Polyethylene (PE-AL-PE) Composite Pressure Pipe
90. F1336- <del>9307</del>	Poly (Vinyl Chloride) (PVC) Gasketed Sewer Fittings
91. F1807- <del>98A07</del>	Metal Insert Fittings Utilizing a Copper Crimp Ring for SDR9 Cross-linked Polyethylene (PEX) Tubing
92. F1866- <del>9807</del>	Poly (Vinyl Chloride) (PVC) Plastic Schedule 40 Drainage and DWV Fabricated Fittings, Specifications for

**Table 81.20-6**

<b>AWS</b>	<b>American Welding Society</b> <b>550 N.W. LeJune Road</b> <b>Miami, Florida 33126</b> <b>Phone: 800-443-9353</b> <b>Web page: <a href="http://www.aws.org/w/a">www.aws.org/w/a</a></b>
------------	--

<b>Standard Reference Number</b>	<b>Title</b>
<del>AWS.A5.8/-92-AWS.A5.8M</del> <u>2004</u>	Filler Metals for Brazing and <u>Braze</u> Welding, Specification for

**Table 81.20-7**

<b>AWWA</b>	<b>American Water Works Association</b> <b>Data Processing Department</b> <b>6666 West Quincy Avenue</b> <b>Denver, Colorado 80235</b> <b>Phone: 303-794-7711</b> <b>Web page: <a href="http://www.awwa.org">www.awwa.org</a></b>
-------------	--

<b>Standard Reference Number</b>	<b>Title</b>
1. C110/ <del>A21.10-9503</del>	American National Standard for Ductile-Iron and Gray-Iron Fittings, <del>3 in. through 48 in., for Water and Other Liquids</del>
2. C111/ <del>A21.11-9507</del>	American National Standard for Rubber-Gasket Joints for Ductile-Iron Pressure Pipe and Fittings
3. C115/ <del>A21.15-9405</del>	American National Standard for Flanged Ductile-Iron Pipe with Ductile-Type Iron or Gray-Iron Pipe Threaded Flanges
4. C151/ <del>A21.51-96-02</del>	<del>American National Standard for Ductile Iron, Centrifugally Cast for Water</del> <u>Ductile-Iron Pipe, Centrifugally Cast, for Water</u>
5. C153/ <del>A21.53-9406</del>	American National Standard for Ductile-Iron Compact Fittings, 3 in. through 16 in., for Water and Other Liquids
5e. C651- <del>9205</del>	Water Mains, Disinfecting

6. C700- <del>9502</del>	Cold Water Meters – Displacement Type with Bronze Main Case (w/ 1991 Addendum)
7. C701- <del>8807</del>	Cold Water Meters – Turbine Type for Customer Service
8. C702- <del>9201</del>	Cold Water Meters – Compound Type
9. C704- <del>9202</del>	Cold Water Meters – Propeller Type for Main Line Applications
10. C706- <del>96(R.05)</del>	Cold Water Meters, Direct-Reading, Remote-Registration Systems for
11. C707- <del>82(R92)05</del>	Cold Water Meters, Encoder-Type, Remote-Registration Systems for
12. C708- <del>9605</del>	Cold Water Meters – Multi-Jet Type
13. C710- <del>9502</del>	Cold Water Meters, Displacement Type – Plastic Main Case (w/1991 Addendum)
14. C900- <del>8907</del>	<u>American Standard for Polyvinyl Chloride (PVC) Pressure Pipe, 4 in. through 12 in. for Water Distribution (w/1992 Addendum) Polyvinyl Chloride (PVC) Pressure Pipe and Fabricated Fittings 4-inch to 12-inch (100mm Through 300mm) for Water Transmission and Distribution.</u>
15. C901-02	<u>Polyethylene (PE) Pressure Pipe and Tubing, ½ in (13mm) Through 3 in (76mm) for Water Service</u>
15. 16. C906- <del>9007</del>	<u>Polyethylene Pressure Pipe and Fittings, 4 in. through 63 in., for Water Distribution</u>

**Table 81.20-7e**

<b>CAN/CSA</b>	<b>Canadian Standards Association 178 Rexdale Boulevard Rexdale (Toronto), Ontario, Canada M9W 1R3 Phone: 800-463-6727 Web page: <a href="http://www.csa.ca">www.csa.ca</a></b>
----------------	---

<b>Standard Reference Number</b>	<b>Title</b>
<u>1. B64-94.1.1-07</u>	<u>Atmospheric Vacuum Breakers</u>
<u>2. B64.1.2-07</u>	<u>Pressure Vacuum Breakers</u>
<u>3. B64.1.3-07</u>	<u>Spill Resistant Vacuum Breakers</u>
<u>4. B64.2-07</u>	<u>Hose Connection Vacuum Breakers</u>
<u>5. B64.2.2-07</u>	<u>Hose Connection Vacuum Breakers with Automatic Draining Feature</u>
<u>6. B64.3-07</u>	<u>Dual Check Valve Backflow Preventers with Atmospheric Port</u>
<u>7. B64.3.1-07</u>	<u>Dual Check Valve Backflow Preventers with Atmospheric Port for Carbonators</u>
<u>8. B64.4-07</u>	<u>Reduced Pressure Principle Backflow Preventers</u>
<u>9. B64.4.1-07</u>	<u>Reduced Pressure Principle Backflow Preventers for Fire Protection Systems</u>
<u>10. B64.5-07</u>	<u>Double Check Valve Backflow Preventers</u>
<u>11. B64.5.1-07</u>	<u>Double Check Valve Backflow Preventers for Fire Protection Systems</u>

<u>12. B64.7-07</u>	<u>Laboratory Faucet Vacuum Breakers</u>
<u>13. CSA B125.1-05</u>	<u>Plumbing Supply Fittings</u>
<del>2. 14. B125-93.3-05</del>	<del>Plumbing Fittings</del>
<u>14e. B125.3-05</u>	<u>Plumbing Fittings – Update No. 1 November 2006</u>
<u>14m. B125.3-05</u>	<u>Plumbing Fittings – Update No. 2 November 2007</u>
<del>3. 15. B137.9-98</del>	<del>Polyethylene / Aluminum / Polyethylene Composite Pressure Pipe Systems</del>
<u>4. 16. B137.10-98</u>	<u>Crosslinked Polyethylene /Aluminum / Crosslinked Polyethylene Composite Pressure Pipe Systems</u>
<del>5. 17. B181.1-9606</del>	<del>Acrylonitrile-butadiene-styrene (ABS) Drain, Waste, and Vent Pipe and Pipe Fittings</del>
<u>6. 18. B181.2-9606</u>	<u>Polyvinylchloride (PVC) and chlorinated polyvinylchloride (CPVC) Drain, Waste, and Vent Pipe and Pipe Fittings</u>

---



**Table 81.20-8**

<b>CISPI</b>	<b>Cast Iron Soil Pipe Institute</b> <b>5959 Shallowford Road, Suite 419</b> <b>Chattanooga, Tennessee 37421</b> <b>Phone: 423-892-0137</b> <b>Web page: <a href="http://www.cispi.org">www.cispi.org</a></b>
<b>Standard Reference Number</b>	<b>Title</b>
1. 301- <u>9705</u>	Hubless Cast Iron Soil Pipe and Fittings for Sanitary and Storm Drain, Waste, and Vent Piping Applications, Standard Specification for
2. 310- <u>9704</u>	Coupling for Use in Connection with Hubless Cast Iron Soil Pipe and Fittings for Sanitary and Storm Drain, Waste, and Vent Piping Applications, Specification for

**Table 81.20-9**

<b>FMRC</b>	<b>Factory Mutual Research Corp.</b> <b>1151 Boston-Providence Turnpike</b> <b>Norwood, Massachusetts 02062</b> <b>Phone: 800-320-6808</b> <b>Web page: <a href="http://www.fmglobal.com">www.fmglobal.com</a></b>
<b>Standard Reference Number</b>	<b>Title</b>
1680	Couplings used in Hubless Cast Iron Systems for Drain, Waste or Vent, Sewer, Rainwater or Storm Drain Systems Above and Below Ground, Industrial/Commercial and Residential, January 1989

SECTION 25. Table 81.20-10 is repealed.

SECTION 26. Table 81.20–10m is renumbered Table 81.20–10 and amended to read:

**Table 81.20–10**

<b>NFPA</b>	<b>National Fire Protection Association 11 Tracy Drive Avon, MA 02322–9908 Phone: 617-770-3000 Web page: <a href="http://www.nfpa.org">www.nfpa.org</a></b>
<b>Standard Reference Number</b>	<b>Title</b>
1. NFPA 13D– <del>2002</del> <u>2007</u>	Installation of Sprinkler Systems in One- and Two-Family Dwellings and Manufactured Homes, <u>Standard for the</u>
2. NFPA 24– <del>2002</del> <u>2007</u>	<u>Standard for the</u> Installation of Private Fire Service Mains and Their Appurtenances, <u>Standard for the</u>

SECTION 27. Tables 81.20–11 to 81.20–13 are amended to read:

**Table 81.20–11**

<b>NSF</b>	<b>NSF International 789 Dixboro Road P.O. Box 130140 Ann Arbor, Michigan 48113–0140 Phone: (800) 673–6275 Web page: <a href="http://www.nsf.org">www.nsf.org</a></b>
<b>Standard Reference Number</b>	<b>Title</b>
1. Standard 14– <del>99</del> <u>2007</u>	<del>Plastic Piping Compounds and Related Materials</del> <u>Plastic Piping System Components and Related Materials</u>
2. Standard 40– <del>99</del> <u>2005</u>	Residential Wastewater Treatment Systems
3. Standard 41– <del>98</del> <u>2005</u>	<del>Non-Liquid</del> Non-liquid Saturated Treatment Systems
3m. <u>Standard 41-2005 Addendum 1</u>	<u>Non-liquid Saturated Treatment Systems</u>
4. Standard 44– <del>98</del> <u>2004</u>	Residential Cation Exchange Water Softeners
5. Standard 51– <del>1997</del> <u>2007</u>	Food Equipment Materials
6. Standard 61– <del>2001</del> <u>2007</u>	Drinking Water System Components Health Effects

**Table 81.20-12**

<b>STI</b>	<b>Steel Tank Institute 570 Oakwood Road Lake Zurich, Illinois 60047 Phone: 617-770-3000 Web page: <a href="http://www.steeltank.com">www.steeltank.com</a></b>
<b>Standard Reference Number</b>	<b>Title</b>
STI-P <sub>3</sub>	External Corrosion Protection of Underground Steel Storage Tanks, Specifications and Manual for, 1996 edition

**Table 81.20-13**

<b>UL</b>	<b>Underwriters Laboratories Inc. 333 Pfingsten Road Northbrook, Illinois 60062 Phone: 847-272-8800 Web page: <a href="http://www.ul.com">www.ul.com</a></b>
<b>Standard Reference Number</b>	<b>Title</b>
1. Standard 58- <del>86</del> 1996	Steel Underground Tanks for Flammable and Combustible Liquids – <u>Ninth Edition</u>
2. Standard 1746- <del>89</del> 2007	External Corrosion Protection Systems for Steel Underground Storage Tanks – <u>Third Edition</u>

SECTION 28. Comm 82.20 (1) (c) (intro.), (4) (b) 2. and (13) (e) are amended to read:

**Comm 82.20 (1) (c)** *Cross connection control assembly registration.* The initial installation of each reduced pressure principle backflow preventer, reduced pressure fire protection principle backflow preventer, ~~back siphonage backflow spill resistant vacuum breaker, reduced pressure detector backflow preventer, reduced pressure detector fire protection backflow prevention assembly~~ or pressure vacuum breaker, shall meet all of the following:

(4) (b) 2. Plans proposing the installation, creation or extension of ~~private sanitary building sewer or~~ a sanitary private interceptor main sewer which is to discharge to a municipal treatment facility shall:

(13) (e) Upon permanent removal or replacement of any reduced pressure principle backflow preventer, reduced pressure fire protection principle backflow preventer, ~~back siphonage backflow spill resistant vacuum breaker, reduced pressure detector backflow preventer, reduced pressure detector fire protection backflow prevention assembly~~, or pressure vacuum breaker, the owner shall notify the department in writing using a format acceptable to the department.

SECTION 29. Comm 82.20 Table 82.20-1 line 7 and Table 82.20-2 line 6. and footnote a are amended to read:

**Table 82.20-1  
(Partial Table)**

**SUBMITTALS TO DEPARTMENT**

**Type of Plumbing Installation**

7. For installation in health care and related facilities, ~~back siphonage backflow~~ spill resistant vacuum breaker.

**Table 82.20-2  
(Partial Table)**

**SUBMITTALS TO DEPARTMENT OR AGENT MUNICIPALITY**

**Type of Plumbing Installation**

6. Water supply systems and drain systems to be installed for ~~mobile home parks~~ manufactured home communities and campgrounds.<sup>c</sup>

<sup>a</sup> Water heaters, floor drains, storm inlets, roof drains and hose bibs are to be counted as plumbing fixtures. For a phased project such as a mall or office complex fixture count includes all proposed fixtures connected to a common building sanitary sewer, a common water service and all storm sewers serving the building.

SECTION 30. Comm 82.21, title is amended to read:

**Comm 82.21 Testing and ~~maintenance~~ inspection.**

SECTION 31. Comm 82.21 (1) (intro.) is amended to read:

**Comm 82.21 (1) TESTING OF PLUMBING SYSTEMS.** Except as provided in par. (a), all new plumbing and all parts of existing systems which have been altered, extended or repaired shall be tested as specified in ~~(d)~~ sub. (2) to disclose leaks and defects before the plumbing is put into operation.

SECTION 32. Comm 82.21 (b) 1. b. is repealed and recreated to read:

**Comm 82.21 (1) (b) 1. b.** Testing may be done without the presence of the inspector, if the master plumber responsible for the installation obtains the inspector's permission to provide a written test report in a format acceptable to the inspector.

**Note:** See the appendix for a sample affidavit form.

SECTION 33. Comm 82.21 (2) is repealed.

SECTION 34. Comm 82.21 (1) (d) is renumbered 82.21 (2).

SECTION 35. Comm 82.21 (3) is renumbered 82.22 (9).

SECTION 36. Comm 82.21 Table 82.21-1 is repealed.

SECTION 37. Comm 82.22 is created to read:

**Comm 82.22 Maintenance and repairs. (1) GENERAL.** (a) All plumbing systems, both existing and new, and all parts thereof, shall be maintained in a safe and sanitary condition.

(b) All devices or safeguards that are required by this chapter shall be maintained in good working order.

(c) The owner shall maintain plumbing systems.

**(2) EXISTING SYSTEMS.** (a) Except as specified in par (b), any existing plumbing system may remain and maintenance continue if the maintenance is in accordance with the original system design and any of the following:

1. The plumbing system was installed in accordance with the code in effect at the time of installation.

2. The plumbing system conforms to the present code.

(b) When a hazard to life, health or property exists or is created by an existing system, that system shall be repaired or replaced.

**Note:** A cross connection is considered a health hazard by the department.

(c) Existing sewers and water services may only be connected to new buildings when determined by examination and test to conform to the requirements of this chapter.

**(3) FIXTURES REPLACED.** 1. When a fixture, appliance or section of pipe is replaced, the replacement fixture, appliance or pipe shall conform to the provisions of this chapter.

2. Where the existing drain or vent piping does not conform to the current provisions of this chapter, the department may require the new fixtures to be provided with deep seal traps.

**(4) PLUMBING REUSED.** (a) 1. Except as provided in par. (b) plumbing materials, fixtures or devices removed and found to be in good condition may be reused if such reuse is approved by the department or a local plumbing inspector.

2. The owner of the building or facility in which the reused materials are to be installed shall provide written consent.

(b) Water supply piping materials may only be reused when the intended use involves an equal or higher degree of hazard than the previous use as specified in Table 82.70-1.

(5) REPAIRS. All repairs to fixtures, devices or piping shall be completed in conformance with the provisions of this chapter, except repair clamps or bands may be used for emergency situations.

(6) DEMOLITION OF STRUCTURES. When a structure is demolished or removed, all sanitary sewer, storm sewer and water supply connections shall be sealed and plugged in a safe manner.

(7) DEAD ENDS. If a dead end is created in the removal of any part of a drain system, all openings in the drain system shall be properly sealed.

(8) TESTING OF CROSS CONNECTION CONTROL ASSEMBLIES.(a) The performance testing requirements of this subsection apply to all cross connection control assemblies regardless of date of installation.

**Note:** For further clarification see Table 82.22-1.

(b) 1. A performance test shall be conducted for the assemblies listed in Table 82.22-1 at all of the following intervals:

- a. At the time of installation.
- b. Immediately after repairs or alterations to the assembly have occurred.
- c. At least annually.

2. The performance test shall be conducted using the appropriate test standard for the assembly as specified in Table 82.22-1.

3. A cross connection assembly performance test shall be conducted by an individual registered by the department in accordance with s. Comm 5.99.

4. a. The results of the cross connection control assembly performance test shall be submitted as specified in Table 82.22-1 in a format prescribed by the department.

b. As specified in Table 82.22-1, the results of the cross connection assembly performance test shall be submitted to the department and purveyor within 60 days of completion of the test.

5. The results of performance tests for the assemblies listed in Table 82.22-1 shall be made available upon request to the department, its agent or the local government unit.

SECTION 38. Comm 82.22 Table 82.22-1 is created to read:

**Table 82.22-1**  
**TESTING AND SUBMITTING REQUIREMENTS FOR CROSS CONNECTION**  
**CONTROL ASSEMBLIES**

ASSE Standard Name and Number	CAN/CSA Standard Name and Number	ASSE Test Standard Number and Test Required	Test Results to be Submitted to Department and Purveyor
Double Check Backflow Prevention Assemblies and Double Check Fire Protection Backflow Prevention Assemblies ASSE 1015	Double Check Valve Backflow Preventers and Double Check Valve Backflow Preventers For Fire Protection Systems CAN/CSA-B64.5.1	5015	No
Double Check Detector Fire Protection Backflow Prevention Assemblies ASSE 1048	-----	5048	No
Pressure Vacuum Breaker Assembly ASSE 1020	Pressure Vacuum Breakers CAN/CSA-B64.1.2	5020	Yes
Reduced Pressure Principle Backflow Preventers and Reduced Pressure Fire Protection Principle Backflow Preventers ASSE 1013	Reduced Pressure Principle Backflow Preventers and Reduced Pressure Principle Backflow Preventers For Fire Protection Systems CAN/CSA-B64.4	5013	Yes
Reduced Pressure Detector Fire Protection Backflow Prevention Assemblies ASSE 1047	-----	5047	Yes
Spill Resistant Vacuum Breaker ASSE 1056	Spill Resistant Vacuum Breakers CAN/CSA B64.1.3	5056	Yes

SECTION 39. Comm 82.30 (3) is amended to read:

**Comm 82.30 (3) LOAD ON DRAIN PIPING.** (a) ~~Intermittent flow fixtures.~~ 1. 'Fixture.' The load factor on drain piping shall be computed in terms of drainage fixture unit values specified in Table 82.30-1 for the corresponding listed fixture ~~listed~~.

2. 'Devices.' Drainage fixture unit values for intermittent flow ~~fixtures~~ devices not listed in Table 82.30-1 shall be computed on the basis of one fixture unit equalling ~~7.5 gallons~~ one gallon per minute of flow.

Note: Equipment with a timed discharge cycle(s) of 2 minutes or less may be considered as an intermittent flow device.

(b) ~~Continuous flow devices.~~ Drainage fixtures unit values for continuous ~~or semicontinuous~~ flow devices such as pumps, ejectors, air conditioning equipment or similar devices that discharge continuously shall be computed on the basis of ~~one 2 fixture unit units~~ one 2 fixture unit units for each ~~2 gallons~~ one gallon per minute of flow ~~rate of discharge into the drain system~~.

SECTION 40. Comm 82.30 (4) (b) is repealed.

SECTION 41. Comm 82.30 (4) (c) to (e) is renumbered 82.30 (4) (b) to (d).

SECTION 42. Comm 82.30 Table 82.30-1 (partial) is amended to read:

**TABLE 82.30-1**  
**(Partial Table)**  
**DRAINAGE FIXTURE UNITS VALUES BY FIXTURE TYPE**

Type of Fixture	Drainage Fixture Unit Value (dfu)	Trap Size Minimum Diameter (inches)
Automatic Clothes Washer:		
Self Service Laundry	<u>34</u>	<u>1½ 2</u>
Residential	<u>34</u>	<u>1½ 2</u>
<del>Mobile home</del> <u>Manufactured home</u>	11	NA



SECTION 43. Comm 82.30 Table 82.30-2 is repealed and recreated to read:

**Table 82.30-2  
HORIZONTAL AND VERTICAL DRAIN PIPING**

Pipe Diameter (inches)	Maximum Number of Drainage Fixture Units That May Drain Through Any Portion of Horizontal and Vertical Drain Piping			
	Horizontal Drain Piping <sup>a</sup>	Vertical Drain Piping <sup>b</sup>		
		Total Discharge from Side Connections into One Branch Interval	Vertical Drain Piping of 3 Branch Intervals or Less <sup>b</sup>	Vertical Drain Piping of More Than 3 Branch Intervals
1 ¼	1	1	2	2
1 ½	3	2	4	8
2	6	6	10	24
3	20	20	48	72
4	160	90	240	500
5	360	200	540	1,100
6	620	350	960	1,900
8	1,400	600	2,200	3,600
10	2,500	1,000	3,800	5,600
12	3,900	1,500	6,000	8,400
15	7,000	c	c	c

- <sup>a</sup> Does not include building drains and building sewers.
- <sup>b</sup> Drain stacks may be reduced in size as the drainage load decreases to a minimum diameter of one half of the diameter required at the base of the stack, but not smaller than that required for a stack vent under s. Comm 82.31 (14) (a)
- <sup>c</sup> Sizing based on design criteria.

SECTION 44. Comm 82.30 Table 82.30-3 (partial) is amended to read:

**Table 82.30-3  
(Partial Table)  
BUILDING DRAINS, BUILDING SUBDRAINS, BUILDING SEWERS AND PRIVATE INTERCEPTOR MAIN SEWERS<sup>a</sup>**

Pipe diameter (Inches)	Maximum Number of Drainage Fixture Units Which May Drain Through Any Portion of a Building Drain, Building Subdrain, Building Sewer or Private Interceptor Main Sewer			
	Pitch (inch per foot)			
	1/16	1/8	1/4	1/2
1 ¼	NP <sup>b</sup>	NP	1	1
1 ½	NP	NP	3	3
2	NP <sup>b</sup>	NP	6	9

SECTION 45. Comm 82.30 (6) (a) 1. is renumbered 82.30 (6) (a).

SECTION 46. Comm 82.30 (6) (a) 2. and (b) 1., 2. and 3. are amended to read:

**Comm 82.30 (6)** (a) 2. Where a horizontal branch connects to a drain stack within 2 feet above or below an offset with a change of direction of 30 to 45° from the vertical and the offset is located ~~below 2 or more~~ 5 or more branch intervals below the top of the stack, the offset shall be vented in accordance with s. Comm 82.31 (5)(a).

**Comm 82.30 (6)** (b) 1. That portion of the drain stack above the highest offset ~~fitting~~ shall be sized as for vertical drain piping in accordance with sub.(4).

2. That portion of the offset between and including the offset fittings shall be sized as ~~horizontal~~ building drain piping in accordance with sub. (4).

3. That portion of stack below the offset shall be not less than the size of the offset, ~~and not less than the size required for vertical drain piping in accordance with sub. (4).~~

SECTION 47. Comm 82.30 (6) (b) 4. and 5. are repealed and recreated to read:

**Comm 82.30 (6)** (b) 4. Where an offset of more than 45° is located more than four branch intervals below the top of the drain stack, a horizontal branch may not connect within the offset or within 2 feet above or below such offset.

5. a. Except as exempted in b., where an offset in a drain stack with a change of more than 45° from vertical is located below 5 or more branch intervals, the offset shall be vented in accordance with 82.31 (5) (b).

b. The vent required in a. shall not be required where the drain stack, including the offset, is sized one pipe size larger than required for a building drain designed to serve as per (4) and the entire stack and offset are not less in cross sectional area than that required for a stack plus the area of a vent as required in 82.31 (5) (b).

SECTION 48. Comm 82.30 (10) (a) 1. is amended to read:

**Comm 82.30 (10)** (a) 1. 'General.' All sanitary building subdrains shall discharge into an approved, vented sump with an airtight cover. The sump shall be so located as to receive the ~~sewage wastewater~~ wastewater by gravity flow, and shall be located at least 25 feet from any water well or as otherwise approved by the department of natural resources.

SECTION 49. Comm 82.30 (11) (e) 2. and 3. are repealed and recreated to read:

**Comm 82.30 (11) (e) 2.** ‘Stable bottom.’ Where the bottom of the trench can be maintained in a stable condition and free of water during the time of installation the building drain and the building sewer shall be bedded and initially backfilled to comply with all the following requirements:

a. Where the trench bottom does not contain stone larger than one inch in size or where bedrock is not encountered, the trench may be excavated to grade.

b. Where stone larger than one inch size or when bedrock is encountered, the trench shall be excavated to a depth at least 3 inches below the grade elevation and shall be brought back to grade with a bedding of sand, gravel or crushed stone that shall be of a size that all the material shall pass a ¾-inch sieve.

c. Bedding shall be sufficiently dry and hand or mechanically compacted to a minimum of 90 percent Standard Proctor Density.

d. Initial backfill to a depth of 12 inches over the pipe shall be sand, crushed stone or excavated material which is neither corrosive nor organic in nature.

e. Initial backfill shall be of a size that passes a one-inch sieve.

f. A concrete floor may be placed over a building drain having less than 12 inches of initial backfill.

g. Initial backfill shall be placed in increments not to exceed 6 inches in depth.

h. Initial backfill shall be well tamped for the full width of the trench and length of the sewer.

3. ‘Unstable bottom.’ Where a mucky or unstable bottom is encountered in the trench, the required dry and stable foundation conditions shall be provided by providing one of the following options:

a. Sheathing shall be driven and left in place to a depth of 48 inches below the trench bottom or to solid foundation to a lesser depth.

b. Removal of wet and yielding material to a depth of 24 inches or to solid material and replacement of the unstable material with limestone screenings, pea gravel or equivalent material.

c. Install a longitudinally reinforced concrete cradle the width of the trench and at least 3 inches thick.

d. Install a longitudinally reinforced concrete slab the width of the trench and at least 3 inches thick.

e. Backfill and bedding shall comply with subd. 2. d. to h.

SECTION 50. Comm 82.30 (11) (f) 2. is repealed and recreated to read:

**Comm 82.30 (11) (f) 2.** 'Pressurized public sewer.' Where a forced building sewer discharges to a pressurized public sewer all of the following requirements shall apply:

- a. A curb stop shall be installed on the same property as close as possible to the connection to the common forced main sewer.
- b. A check valve shall be installed in the pressurized building drain or building sewer.
- c. An accessible quick disconnect shall be installed upstream of the check valve.

SECTION 51. Comm 82.30 (11) (h) 1. g. to i. are renumbered 82.30 (11) (h) 1. h. to j.

SECTION 52. Comm 82.30 (11) (h) 1. g. is created to read:

**Comm 82.30 (11) (h) 1. g.** Where tracer wire is more than 6 inches from the pipe, tracer wire insulation color shall comply with sub. 1. h.

SECTION 53. Comm 82.31 (4) (a) is amended to read:

**Comm 82.31 (4) (a)** *Where required.* ~~Where individual vents, relief vents, or other branch vents are required, a~~ A vent stack and a stack vent shall be installed to serve ~~all~~ any drain stacks of ~~2-5~~ or more branch intervals.

SECTION 54. Comm 82.31 (5) and (6) are repealed and recreated to read:

**Comm 82.31 (5) RELIEF AND YOKE VENTS FOR STACK OFFSETS.** (a) *Vents serving offsets of 30 to 45° in drain stacks.* 1. Except as permitted in 2., where a horizontal branch connects to a drain stack within 2 feet above or below an offset with a change of direction of 30 to 45° from the vertical and the offset is located below 5 or more branch intervals, the offset shall be vented in accordance with (b) 1. to 3.

2. Where the drain stack and offset are sized as building drain as per Table 82.30-3, the vent serving the offset of 30 to 45° in a drain stack is not required.

(b) *Vents serving offsets of more than 45° in drain stacks.* Offsets of more than 45° in drain stacks shall be vented where 5 or more branch intervals are located above the offset. The offset shall be vented by venting the upper and lower section of the stack.

1. *Upper section.* The upper section of the stack shall be vented as a separate stack with a vent stack connection installed in accordance with par. (4). The offset shall be considered the base of the stack.

2. *Vent connection above offset.* The vent stack shall connect with a wye pattern fitting above the stack offset and at or below the lowest drain branch above the offset.

3. *Lower section.* The lower section of the stack shall be vented by a yoke vent connecting below the offset above or at the next lower horizontal branch.

a. Except as provided in b., the connection of the yoke vent to the drain stack shall be by means of a wye pattern fitting.

b. The yoke vent connection may be a vertical extension of the stack.

c. The connection of the yoke vent to another vent shall not be less than 38 inches above the next higher floor level where plumbing fixtures are installed that discharge into the drain stack.

**(6) RELIEF VENTS FOR STACKS OF MORE THAN 10 BRANCH INTERVALS.** (a) Drain stacks of more than 10 branch intervals shall be provided with a relief vent at each tenth interval installed.

(b) The lower end of the relief vent required in (a) shall connect to the stack by use of a wye pattern fitting below the horizontal branch serving that floor.

(c) The upper end of the relief vent required in (a) shall connect to the vent stack by means of a wye pattern fitting not less than 3 feet above the floor level with the highest fixtures.

SECTION 55. Comm 82.31 (10) (c), (13) 1. e., (14) (g) 2. and (17) (a) 1. e. are amended to read:

**Comm 82.31 (10)** (c) A horizontal drain served by a circuit vent ~~shall~~ may not diminish in size from the ~~connection to the drain stack~~ most downstream fixture drain connection vented by the circuit vented drain to the circuit vent connection. Where a relief vent is installed, the horizontal drain served by the circuit vent shall not diminish in size from the relief vent connection to the circuit vent connection.

**(13)** (a) 1. e. The higher fixture drain may not serve a water closet ~~or urinal~~.

**(14)** (g) 2. 'Drain stacks.' A relief vent serving an offset in a drain stack shall be sized as a stack vent in accordance with par. (a).

**(17)** (a) 1.e. The drain stack and its attendant ~~stack~~ vent shall be sized in accordance with Table 82.31-5.

SECTION 56. Comm 82.31(17) (a) 1. f. is repealed.

SECTION 57. Comm 82.31 (17) (b) 1. and 3. a. are amended to read:

**Comm 82.31 (17)** (b) 1. A vent ~~stack~~ or drain ~~stack~~ at least 2<sup>2</sup> inches in diameter shall be connected upstream of any building drain branch or building subdrain branch.

3. a. That portion of the building drain or building subdrain between the connection of the building drain branch or building subdrain branch and the vent ~~stack~~ or drain ~~stack~~ required in subd. 1. shall be at least one pipe size larger than the minimum size permitted in Table 82.30-3 based on the total drainage fixture unit load, but not less than 3 inches.

b. The vent ~~stack~~ or drain ~~stack~~ required in subd. 1. shall be at least one-half the diameter of that portion of the building drain or building subdrain which is vented by the vent or drain stack, but may not be less than 2<sup>2</sup> inches in diameter.

c. A ~~stack~~-vent serving a drain ~~stack~~ required in subd. 1, shall be at least one half the diameter of that portion of the building drain or building subdrain which is vented by the ~~stack~~, system, but may not be less than 2<sup>2</sup> inches in diameter.

SECTION 58. Comm 82.32 (4) (b) 2. c. is created to read:

**Comm 82.32 (4)** (b) 2. c. The minimum horizontal distance between the vertical centerline of the outlet from a floor-mounted water closet and a 3-inch double tee shall be 30 inches.

SECTION 59. Comm 82.33 (7) (a) is repealed and recreated to read:

**Comm 82.33 (7)** (a) *Air-gap installation*. The installation of an air gap shall conform to any of the following requirements:

1. The distance of an air gap shall comply with one of the following:

a. The distance of an air gap serving indirect waste piping one inch or less in diameter and a receptor shall be at least twice the diameter of the indirect waste piping.

b. The distance of an air gap between indirect waste piping larger than one inch in diameter and a receptor shall not be less than 2 inches.

2. The installation of all air-gap fittings shall comply with ASME A112.1.3.

3. The installation of a residential dishwashing machine manufactured air gap shall comply with ASSE 1021.

SECTION 60. Comm 82.33 (8) (d) 6. and 7. are created to read:

**Comm 82.33 (8)** (d) 6. The indirect or local waste piping serving a water heater temperature and pressure relief valve or water treatment device may discharge through the cover

of a clear water sump so as not to adversely affect floats by means of a fixed air gap installed in accordance with subs. (7) (a) 2. and (8).

7. The indirect waste piping serving a dental mold grinder may discharge into the riser or a trap serving a laboratory sink that is provided with a plaster trap and is installed within 3 feet of the mold grinder.

SECTION 61. Comm 82.33 (9) (c) 1. a. and b. are amended to read:

**Comm 82.33 (9) (c) 1 a.** A standpipe receptor may not extend more than 36<sup>22</sup> inches nor less than 18<sup>22</sup> inches above the ~~top of the trap weir~~ centerline of the trap outlet.

b. A ~~1½ inch diameter~~ standpipe receptor shall terminate at least 32<sup>22</sup> 26 inches but not more than 48<sup>22</sup> inches above the floor on which the clothes washer is located.

SECTION 62. Comm 82.33 (9) (c) 1. c. is repealed.

SECTION 63. Comm 82.33 (9) (f) 1. is amended to read:

**Comm 82.33 (9) (f) 1.** All drains serving elevator pits shall discharge to the storm drain system as specified in s. Comm 82.36 ~~(3)(4)~~.

SECTION 64. Comm 82.34 (3) (a) 1. is amended to read:

**Comm 82.34 (3) (a) 1.** Except as provided in subd. 2., wastewater discharged from water closets or urinals shall not be reused for drinking water ~~or treated for reuse~~.

SECTION 65. Comm 82.34 (4) (b) 2. is repealed and recreated to read:

**Comm 82.34 (4) (b) 2. a.** Except as permitted in subd. 2. b., catch basins serving garages for one- and 2-family dwellings shall be designed and installed in accordance with par. (a) 2.

b. The minimum inside diameter of catch basins serving garages for one- and 2-family dwellings shall be 18 inches.

SECTION 66. Comm 82.34 (5) (intro.) to (d) are renumbered Comm 82.34 (5) (a) to (e) and as renumbered 82.34 (5) (a) and (b) are amended to read:

**Comm 82.34 (5) GREASE INTERCEPTORS AND OIL TREATMENT.** (a) All plumbing installations for occupancies, other than dwelling units, where grease, fats, oils or similar waste products of cooking or food are introduced into the drain system shall be provided with interceptors grease and oil treatment in accordance with this subsection. ~~All drains and~~

~~drain piping carrying oil, grease or fats shall be directed through one or more interceptors as specified in par. (a).~~

~~(a)~~ (b) *General.* 1. 'Public sewers.' All new, altered or remodeled plumbing systems which discharge to public sewers shall be provided with one or more ~~exterior grease interceptors or one or more interior grease interceptors.~~

a. Where one or more exterior grease interceptors are provided all and only kitchen wastes shall be discharged to an exterior interceptor.

b. ~~Where~~ Except as required in subd. 1. c. or d., where one or more interior grease interceptors are provided the wastes from a food waste grinder, or a sanitizing compartment of a sink or a rinse compartment of a sink or both, may bypass the interceptor or interceptors.

c. The wash compartment of a scullery sink shall discharge through a grease interceptor.

d. The pre-wash compartment not discharging through a garbage disposal shall discharge through a grease interceptor.

2. 'Private onsite wastewater treatment systems.' All new, altered or remodeled plumbing systems, which discharge to private onsite wastewater treatment systems shall be provided with exterior grease interceptors.

a. Except as provided in subd. 2. b., only kitchen and food wastes shall be discharged to an exterior grease interceptor.

b. ~~Where approved by the department~~ For remodeling, when it is not practicable to separate kitchen and toilet wastes, combined kitchen wastes and toilet wastes may be discharged directly to a septic private onsite wastewater treatment component tank or tanks which conform to par. ~~(b)~~ (c). The required capacity of a grease interceptor shall be added to the required septic tank capacity as specified in ch. Comm 83.

c. For holding tank installations, the combined kitchen and toilet wastes may discharge directly to a holding tank where the location accepting the pumpage from the tank provides written acceptance of the combined waste to the department.

3. 'Existing installations.' The department may require the installation of ~~either interior or exterior interceptors~~ any treatment device deemed necessary by the department for existing plumbing installations where the waterway of a drain system, sewer system or private onsite wastewater treatment system is reduced or filled due to ~~congealed~~ grease.

SECTION 67. Comm 82.34 (5) (c) 7. is created to read:

**Comm 82.34 (5) (c) 7.** A maximum of 12 inches of horizontal inlet pipe may be submerged.

SECTION 68. Comm 82.34 (14) (a) 2. is repealed and recreated to read:



**Comm 82.34 (14)** (a) 2. Dilution and neutralizing basins shall have the minimum retention capacities in accordance with one of the following requirements:

- a. The minimum retention capacity shall be as specified in Table 82.34.
- b. The minimum retention capacity shall be as per the manufacturer's specifications.
- c. The minimum retention capacity for a quantity exceeding 150 sinks or for special uses or installations shall be approved by the department.

SECTION 69. Comm 82.35 (3) (a) is repealed and recreated to read:

**Comm. 82.35 (3)** (a) *Horizontal drains*. All gravity horizontal drains within or under a building shall be accessible through a cleanout in accordance with one of the following requirements:

1. The developed length of drain piping between cleanouts for above-ground piping may not exceed 75 feet.
2. The developed length of drain piping between cleanouts for below ground piping 2 inches or less in diameter may not exceed 40 feet.
3. The developed length of drain piping between cleanouts for below ground piping greater than 2 inches in diameter may not exceed 75 feet.

**Note:** See appendix for further explanatory material.

SECTION 70. Comm 82.35 Table 82.35 (partial) is amended to read:

**Table 82.35  
(Partial Table)  
CLEANOUT SIZES**

Diameter of Pipe Served By Cleanout (inches)	Minimum Diameter of Cleanout Extension (inches)	Minimum Diameter of Cleanout Opening (inches)
1 ¼	1 ¼	1 ¼
1 ½	1 ½	1 ½ 1 ¼

SECTION 71. Comm 82.35 (3) (b) 2. a. and b., (c) 2. a. and b. and (d) 2. b. and c. are amended to read:

**Comm 82.35 (3) (b) 2. a.** Every horizontal change in direction of more than 45° degrees ~~or more~~ where the change in direction is created within a distance of less than 10 feet;

b. Every change in pipe diameters where both connections are 8 inches or larger; and

(c) 2. a. Every horizontal change in direction of more than 45 degrees ~~or more~~ where the change in direction is created within a distance of less than 10 feet,

b. Every change in pipe diameter where both connections are 12 inches or larger, and

(d) 2. b. Every horizontal change in direction of more than 45 degrees ~~or more~~ where the change in direction is created within a distance of less than 10 feet,

c. Every change in pipe diameter where both connections are 6 inches or larger, and

SECTION 72. Comm 82.35 (5) (a) 1. is amended to read:

**Comm 82.35 (5) (a) 1.** All interior and exterior cleanouts where the vertical distance between the ~~centerline of the~~ horizontal drain pipe being served and the top of the cleanout opening exceeds 18<sup>22</sup> inches in length, shall connect to the drain piping through a fitting as specified in Table 82.30-4.

SECTION 73. Comm 82.36 (4) (b) 3. and (8) (a) 4. are amended to read:

**Comm 82.36 (4) (b) 3.** Stormwater gravity drains shall not be combined with clearwater drains prior to discharging to the storm building drain, ~~unless the clearwater drains are protected by a check valve or backwater valve~~ except where approved by the department.

**(8) (a) 4. 'Size'.** ~~a. Except as recommended by the pump manufacturer permitted under~~ subd. 4. b. or c. the size of each sump shall be no smaller than 16<sup>22</sup> inches in diameter at the top, 14<sup>22</sup> inches in diameter at the bottom, and 22<sup>22</sup> inches in depth.

b. The minimum sump diameter may be smaller than 16 inches when specified by the manufacturer for a combination sump and pump.

c. A sump located in an elevator pit may have a width or diameter of not less than 12 inches and a depth of not less than 12 inches.

SECTION 74. Comm 82.36 (11) is repealed and recreated to read:

**Comm 82.36 (11) SECONDARY ROOF DRAINS** (a) *Sizing*. When secondary roof drain systems are installed the secondary system shall be sized and installed in accordance with the requirements in this section.

(b) *Prohibited connection*. Secondary roof drain systems may not be connected to primary roof drain systems.

(c) *Discharge*. All secondary roof drain systems shall discharge in accordance with Table 82.38-1.

SECTION 75. Comm 82.37 (3) (b) 3. is amended to read:

**Comm 82.37 (3)** (b) 3. A campsite water supply riser shall terminate no less than ~~42~~<sup>18</sup> 18 inches above finished grade.

SECTION 76. Comm 82.38 Table 82.38–1 lines 10 to 17 and footnote g and j are amended to read:

**Table 82.38–1  
(Partial Table)**

**ALLOWABLE DISCHARGE POINTS BY FIXTURE OR SPECIFIC USES**

Use or Fixture	Allowable Discharge Points					
	POWTS <sup>a</sup>	Municipal Sanitary Sewer	Municipal Storm Sewer	Ground Surface	Combined Sanitary-Storm Sewer	Subsurface Dispersal <sup>i</sup>
<del>10.</del> <u>10.</u> Residential living unit air conditioner condensate	X	X <sup>g</sup>	X <sup>c</sup>	X <sup>b</sup>	X	X
<del>40.</del> <u>11.</u> Storm water, groundwater, fire sprinkler test discharge and clear water	X	X <sup>g</sup>	X <sup>c</sup>	X <sup>b</sup>	X	X
<del>12.</del> <u>12.</u> Secondary roof drain systems				X <sup>j</sup>		
<del>11.</del> <u>13.</u> Swimming pool or wading pool – diatomaceous earth filter backwash	X	X			X	
<del>12.</del> <u>14.</u> Swimming pool or wading pool – drain wastewater	X	X <sup>b</sup>	X <sup>b,c</sup>	X <sup>b,c</sup>	X <sup>b</sup>	X
<del>13.</del> <u>15.</u> Swimming pool or wading pool – sand filter backwash	X	X <sup>b</sup>	X <sup>b,c</sup>	X <sup>b,c</sup>	X <sup>b</sup>	X
<del>14.</del> <u>16.</u> Water heater temperature and pressure relief valve [see s. Comm 82.40 (5)]	X	X	X	X <sup>b</sup>	X	X
<del>15.</del> <u>17.</u> Wastewater from water treatment device	X	X	X <sup>c</sup>	X <sup>b,c</sup>	X	X
<del>16.</del> <u>18.</u> Whirlpool backwash drain and wastewater	X	X	X <sup>c</sup>	X <sup>b,c</sup>	X	
<del>17.</del> <u>19.</u> Discharges not specifically listed above	Contact the department.					

<sup>g</sup> Fifty ~~gal~~ gal clear water gallons per day.

<sup>j</sup> Discharge separate from the primary system and where observable.

SECTION 77. Comm 82.40 Table 82.40-1 (partial) and Table 82.40-2 (partial) are amended to read:

**Table 82.40-1  
(Partial Table)  
WATER SUPPLY FIXTURE UNITS FOR  
NONPUBLIC USE FIXTURES**

Type of Fixture <sup>a</sup>	Water Supply Fixture Units (wsfu)		
	Hot	Cold	Total
<del>Mobile</del> <u>Manufactured</u> Home	---	15	15

**Table 82.40-2  
(Partial Table)  
WATER SUPPLY FIXTURE UNITS FOR  
PUBLIC USE FIXTURES**

Type of Fixture <sup>a</sup>	Water Supply Fixture Units (wsfu)		
	Hot	Cold	Total
<del>Service sink</del>	<del>2.0</del>	<del>2.0</del>	<del>3.0</del>
Sinks:			
Bar and Fountain	1.5	1.5	2.0
Barber and Shampoo	1.5	1.5	2.0
Cup		0.5	0.5
Flushing Rim		7.0	7.0
Kitchen and Food Preparation per faucet	2.0	2.0	3.0
Laboratory	1.0	1.0	1.5
<u>Service Sink</u>	<u>2.0</u>	<u>2.0</u>	<u>3.0</u>

SECTION 78. Comm 82.40 (3) (b) 1. b. and (d) 3. are amended to read:

**Comm 82.40 (3) (b) 1. b.** Tempered water supplied to serve multiple lavatories, wash fountains and shower heads shall be provided by means of ~~thermostatic~~ temperature-actuated mixing valves that comply with ASSE 1017.

(d) 3. The installation of each ~~reduced pressure principle backflow preventer, reduced pressure detector backflow preventer, pressure vacuum breaker assembly, and back siphonage backflow vacuum breaker~~ reduced pressure principle backflow preventer, reduced pressure fire protection principle backflow preventer, reduced pressure detector fire protection backflow preventer, spill resistant vacuum breaker and pressure vacuum breaker shall display a department assigned identification number. ~~The provisions of this subdivision shall take effect September 1, 2001.~~

SECTION 79. Comm 82.40 (3) (e) is repealed and recreated to read:

**Comm 82.40 (3) (e) *Multipurpose piping system.*** 1. Except as provided in subd. 2., a multipurpose piping system shall be designed and installed in accordance with this section and NFPA 13D.

**Note:** Pursuant to this subdivision and sub. (2), materials for multipurpose piping systems need to be acceptable under the NFPA 13D standard and s. Comm 84.30, Table 84.30-9.

2. a. Fire department connections are prohibited in a multipurpose piping system.

b. Sections 7.6, 6.3(4), 8.1.3 and 8.6 of NFPA 13D do not apply in Wisconsin.

c. A multipurpose piping system conforming with all sections of NFPA 13D shall add the following wording to the warning sign required in 6.3(5) of NFPA 13D: “The number and location of sprinklers in this system conform with NFPA 13D.”

**Note:** See Appendix A-82.40 (4) for further explanatory material.

d. A multipurpose piping system that does not conform with all sections of NFPA 13D shall add the following wording to the warning sign required in 6.3 (5) of NFPA 13D: “The number and location of sprinklers in this system does not conform with NFPA 13D.”

SECTION 80. Comm 82.40 (5) (c) and (6) (a) are amended to read:

**Comm 82.40 (5) (c) *Water heaters.*** All water heaters and safety devices shall be designed and constructed in accordance with s. Comm 84.20 (5) ~~(m)~~-(p).

**(6) (a) *Intermittent flow fixtures.*** The load factor for intermittent flow fixtures on water supply piping shall be computed in terms of water supply fixture units as specified in Table 82.40-1 and 82.40-2 for the corresponding fixture and use. Water supply fixture units may be converted to gallons per minute in accordance with ~~Table~~ Tables 82.40-3 or 82.40-3e.

SECTION 81. Comm 82.40, Table 82.40–3e is created to read:

**Table 82.40–3e  
CONVERSION OF WATER SUPPLY FIXTURE UNITS  
TO GALLONS PER MINUTE FOR  
WATER TREATMENT DEVICES<sup>a</sup> SERVING AN INDIVIDUAL DWELLING<sup>b</sup>**

Water Supply Fixture Units (WSFUs)	Gallons Per Minute (GPM)
1	1
2	2
3	3
4	4
5	4.5
6	5
7	6
8	6.5
25	7
35	8
40	9

<sup>a</sup> Treatment devices providing treatment for compliance with Table 82.70–1 shall use Table 82.40–2 for conversion.

<sup>b</sup> Table shall not be used for converting hose bibb, high flow fixture or hydrant wsfu.

SECTION 82. Comm 82.40 (7) (d) 1. b. is amended to read:

**Comm 82.40 (7) (d) 1. b.** The flow pressure at the outlets of the fixture supplies serving one piece tank type water closets, pressure balance mixing valves, ~~mobile~~ manufactured homes, and thermostatic mixing valves shall be at least 20 psig.

SECTION 83. Comm 82.40 (8) (b) 2. is amended to read:

**Comm 82.40 (8) (b) 2.** Except as provided in subd. 3., exterior ~~Exterior~~ water supply piping shall be located at least 10 feet horizontally away from a non-pressurized POWTS ~~treatment, holding or dispersal~~ component.

SECTION 84. Comm 82.40 (8) (b) 8. is created to read:

**Comm 82.40 (8) (b) 8.** Except as provided in subd. 3., no private water main or water service may be installed within 15 feet of a pressurized sanitary sewer or POWTS pump discharge piping.

SECTION 85. Comm 82.40 (8) (d) 3. is renumbered 82.40 (8) (d) 3. a.

SECTION 86. Comm 82.40 (8) (d) 3. b. is created to read:

**Comm 82.40 (8)** (d) 3. b. The minimum diameter of water distribution piping serving as a meter bypass shall be one nominal pipe size smaller than the meter.

SECTION 87. Comm 82.40 (8) (e) 2. is repealed and recreated to read:

**Comm 82.40 (8)** (e) 2. Stop- and waste-type control valves may not be installed underground except in the following situations:

- a. Fire hydrants intended for fire fighting.
- b. Two-inch and larger diameter hydrants serving municipal wastewater treatment plants.
- c. Emergency fixtures.

SECTION 88. Comm 82.40 (8) (j) is amended to read:

**Comm 82.40 (8)** (j) *Water softeners*. Ion exchange water softeners used primarily for water hardness reduction that, during regeneration, discharge a brine solution ~~into a private onsite wastewater treatment system~~ shall be of a demand initiated regeneration type equipped with a water meter or a sensor unless ~~the design of the private onsite wastewater~~ a wastewater treatment system downstream of the water softener specifically documents the reduction of chlorides.



SECTION 89. Comm 82.41 Table 82.41-1 (partial), is amended to read:

**ACCEPTABLE CROSS CONNECTION CONTROL METHODS, DEVICES  
OR ASSEMBLIES FOR SPECIFIC APPLICATIONS**

Methods or Assemblies of Cross Connection Control (Standard)	Situations and Conditions							
	Backpressure				Backsiphonage			
	Low Hazard		High Hazard		Low Hazard		High Hazard	
	Contin-uous	Noncon-tinuous	Contin-uous	Noncon-tinuous	Contin-uous	Noncon-tinuous	Contin-uous	Noncon-tinuous
	Pressure		Pressure		Pressure		Pressure	
Atmospheric Type Vacuum Breaker (CAN/CSA B64.1.1)						X		X
<del>Back Siphonage</del> Spill Resistant Vacuum Breaker (ASSE 1056 and CAN/CSA B64.1.3)					X	X	X	X
Hose Connection Type Vacuum Breakers (CAN/CSA B64.2.1-B64.2 and B64.2.2)	X <sup>a</sup>	X	X <sup>a</sup>	X	X <sup>a</sup>	X	X <sup>a</sup>	X
Pressure Type Vacuum Breaker (CAN/CSA B64.1.2)					X	X	X	X
Reduced Pressure Principle Type Backflow Preventer (CAN/CSA B64.4)	X	X	X	X	X	X	X	X

SECTION 90. Comm 82.41 (3) (b) 4. e. is created to read:

**Comm 82.41 (3) (b) 4. e.** In the water supply piping connecting to the outlet of a fire hydrant for any purpose other than fire suppression.

SECTION 91. Comm 82.41 Table 82.41–2 (partial) is amended to read:

**Table 82.41–2  
(Partial Table)  
ACCEPTABLE CROSS CONNECTION CONTROL METHODS, DEVICES  
OR ASSEMBLIES  
FOR SPECIFIC APPLICATIONS**

Methods or Assemblies of <del>Cross Connection Control</del> <b>Control</b> (Standard)	Types of Application or Use
<u>Double Check Backflow Prevention Assemblies and Double Check Fire Protection Backflow Prevention Assemblies</u> (ASSE 1015)	Automatic fire sprinkler systems and standpipe systems Water-based fire protection system
<u>Double Check Detector Assembly Fire Protection Backflow Preventer Prevention Assemblies</u> (ASSE 1048)	Automatic fire sprinkler systems and standpipe systems Water-based fire protection system
<u>Dual Check Backflow Preventer Wall Hydrant – Freeze Resistant Type</u> (ASSE 1053)	<u>Hose threaded outlet connection</u>

SECTION 92. Comm 82.41 (4) (c) 1. a., (f) (i), and (n) and (5) (a), (e) 2. and (f) (intro.) are amended to read:

**Comm 82.41 (4) (c) 1. a.** The use of a hose connection backflow preventer, ~~and dual check backflow preventer wall hydrant-freeze resistant~~ or a hose connection vacuum breaker in a continuous pressure situation shall be limited to campgrounds and marinas.

(f) A hand-held shower may not be employed in backpressure situations of more than ~~2~~ 5 feet of water column.

(i) A vacuum breaker wall hydrant, freeze resistant automatic draining type ~~or a freeze resistant sanitary yard hydrant~~, may not be employed in backpressure situations of more than 10 feet of water column.

(n) A ~~back siphonage spill resistant~~ vacuum breaker shall be installed so that the bottom of the device or the critical level mark on the device is at least 12" above all the following:

**(5) (a)** An ~~air gap~~ air gap for cross connection control shall conform to ASME A112.1.2 ~~or ASME A112.1.3.~~

(e) 2. Cross connection control devices ~~or assemblies~~ shall be so located that any vent ports ~~of the devices shall be~~ are provided with an air gap ~~in accordance with par. (a) or ASME A112.1.3.~~ so as to comply with ASME A112.1.2 or ASME A112.1.3.

(f) The installation of a reduced pressure principle backflow preventer, a reduced pressure fire protection principle backflow preventer, a reduced pressure detector backflow preventer, a reduced pressure detector fire protection backflow prevention assembly, a double check backflow prevention assembly, a double check detector assembly backflow preventer, a

pressure vacuum breaker assembly and a ~~back siphonage backflow~~ spill resistant vacuum breaker shall conform to all of the following limitations:

SECTION 93. Comm 82.50 (3) (b) 5. is amended to read:

**Comm 82.50 (3) (b) 5.** Water provided to patient showers, therapeutic equipment and all types of baths shall be installed with control valves which automatically regulate the temperature of the water supply to the fixture fitting outlet within a temperature range of 110°F to 115°F. Such control valves shall automatically reduce flow to 0.5 gpm or less when the water supply to the fitting outlet exceeds 115°F or when loss of cold water pressure occurs.

SECTION 94. Comm 82.51 is amended to read:

**Comm 82.51 ~~Mobile Manufactured homes and mobile home parks~~ manufactured home communities.** (1) DRAIN SYSTEMS. Except as provided in pars. (a) and (b), the building sewers and private interceptor main sewers serving a ~~mobile manufactured home or mobile home park~~ manufactured home community shall comply with s. Comm 82.30.

(a) The minimum slope of the aboveground building sewer shall be 1/8<sup>22</sup> inch per foot.

(b) For ~~mobile manufactured~~ homes, the most upstream point of the building sewer shall be determined at the connection with the building drain installed by the ~~mobile manufactured~~ home manufacturer prior to delivery.

(c) The above ground building sewer shall be constructed of materials suitable for above ground drain and vent as specified in s. Comm 84.30 (2) (a).

(2) WATER SUPPLY SYSTEMS. (a) Except as provided in pars. (b) and (c), the water services and private water mains for a ~~mobile manufactured home or mobile home park~~ manufactured home community shall comply with s. Comm 82.40.

(b) The above ground water service shall be constructed of materials approved for water distribution as specified in s. Comm 84.30 (4) (e).

(c) The curb stop serving an individual ~~mobile manufactured~~ home shall terminate outside the perimeter of the ~~mobile manufactured~~ home.

(d) For ~~mobile manufactured~~ homes, the most downstream point of the water service shall be determined at the connection with the water distribution piping by the ~~mobile manufactured~~ home manufacturer prior to delivery.

(3) ~~MOBILE MANUFACTURED~~ HOME CONNECTIONS. (a) Frost sleeves for plumbing serving a ~~mobile manufactured~~ home shall conform to all of the following:

1. Water service and building sewer connections shall be provided with frost sleeves extending to within 6<sup>22</sup> inches of the top of the below ground horizontal building sewer or water service, or to a depth at least 6<sup>22</sup> inches below the predicted depth of frost in accordance with Table 82.30-6.

2. The frost sleeve shall terminate at least 2<sup>22</sup> inches above grade.

3. The sleeve shall be constructed of material approved for building drain or building sewer material as specified in s. Comm 84.30 (2).

(b) Termination of the water service and building sewer shall conform to all of the following:

1. The ~~mobile manufactured~~ home water service for connection to the ~~mobile manufactured~~ home shall terminate a minimum of 6<sup>22</sup> inches above the surrounding finished grade.

2. The ~~mobile manufactured~~ home building sewer for connection to the ~~mobile manufactured~~ home shall terminate a minimum of 4<sup>22</sup> inches above the surrounding finished grade and may not terminate higher than the water service.

(c) The ~~mobile manufactured~~ home water service and building sewer shall be capped or plugged when not connected to a ~~mobile manufactured~~ home.

**Note:** See Appendix A-82.51 (3) for further explanatory material.

SECTION 95. Comm 82.70 Table 82.70-1 lines 2 and 10 and footnote e are amended to read:

**Table 82.70-1  
(Partial Table)  
PLUMBING TREATMENT STANDARDS**

Intended Use	Plumbing Treatment Standards <sup>f</sup>
2. Personal hygiene, bathing and showering- <del>clothes washing.</del>	NR 811 and 812 approved sources.
10. Surface irrigation except food crops, vehicle washing, toilet and urinal flushing, <u>clothes washing</u> , air conditioning, soil compaction, dust control, washing aggregate and making concrete <sup>a,c,e</sup>	pH 6-9 <sup>b</sup> ≤ 10 mg/L BOD <sub>5</sub> ≤ 5 mg/L TSS No detectable fecal coliform cfu/100mL ≥ 1 mg/L and ≤ 10 mg/L free chlorine residual <sup>b</sup>

<sup>a</sup>Applies to reuse not stormwater use.

SECTION 96. Comm 84.10, Table 84.10 line 8. is repealed.

SECTION 97. Comm 84.11, Table 84.11 is amended to read:

**Table 84.11  
DEVICE LISTINGS**

Formatted: Tab stops: Not at 3" + 6"

<b>Device</b>	<b>Referenced Standard</b>
<del>Atmospheric Type</del> Vacuum Breakers	CAN/CSA B64.1.1
<del>Back Siphonage</del> <u>Spill Resistant</u> Vacuum Breakers	ASSE 1056
Backflow Preventers for <del>Carbonated</del> Beverage <u>Dispensing Equipment</u> <del>Machines</del>	ASSE 1022
Backflow <del>Preventers</del> <u>Preventer</u> with Intermediate Atmospheric Vent	ASSE 1012
Chemical Dispensing Systems	ASSE 1055
Double Check Backflow Prevention Assemblies and <u>Double Check Fire Protection Backflow Prevention Assemblies</u>	ASSE 1015
Double Check Detector Fire Protection Backflow Prevention <u>Assemblies</u> <del>Assembly Preventers</del>	ASSE 1048
Double Check Valve <del>Type</del> Backflow Preventers	CAN/CSA B64.5
Dual Check Valve <del>Type</del> Backflow Preventers with Atmospheric Port <del>Backflow Preventers</del>	CAN/CSA B64.3
Backflow Prevention Devices for Hand-Held <del>Hand Held</del> Showers	ASSE 1014
Hose Connection Backflow Preventers	ASSE 1052
Hose Connection <del>Type</del> Vacuum Breakers	CAN/CSA B64.2
Hose Connection Vacuum Breakers	ASSE 1011
Laboratory Faucet Backflow Preventers	ASSE 1035
Laboratory Faucet Type Vacuum Breakers	CAN/CSA B64.7
<del>Pipe Applied</del> Atmospheric Type Vacuum Breakers	ASSE 1001
Pressure <del>Type</del> Vacuum Breakers	CAN/CSA B64.1.2
Pressure Vacuum <del>Breakers</del> <u>Breaker Assembly</u>	ASSE 1020
Pressurized Flushing Devices (Flushometers) for Plumbing Fixtures	ASSE 1037
Reduced Pressure Detector Fire Protection, Backflow Prevention Assemblies	ASSE 1047
Reduced Pressure Principle Backflow Preventers and Reduced Pressure Fire Protection Principle Backflow Preventers	ASSE 1013
Reduced Pressure Principle <del>Type</del> Backflow Preventers	CAN/CSA B64.4
<u>Anti-siphon Fill Valves (Ballcocks) for Gravity Water Closet Flush Tank</u> <del>Ballcocks Tanks</del>	ASSE 1002
<u>Vacuum Breaker</u> Wall Hydrants, Freeze Resistant, Automatic Draining Type	ASSE 1019
Residential Cation Exchange Water Softeners	NSF 44

**History:** Cr. Register, July, 2000, No. 535, eff. 9-1-00; CR 02-002: am. Table Register April 2003 No. 568, eff. 5-1-03; **CR 04-035: am. Table 84.11 Register November 2004 No. 587, eff. 12-1-04.**

SECTION 98. Comm 84.20 (3) (b) 2. to 8. are amended to read:

**Comm 84.20 (3) (b) 2.** ‘Lavatory faucet.’ a. The maximum discharge rate of lavatory faucets shall be ~~3~~ 2.2 U.S. gallons per minute at ~~an 80 a 60~~ psig flowing supply pressure.

b. Lavatory faucets ~~which that~~ are of the ~~self-closing metering~~ type shall allow a maximum of ~~one 0.25~~ U.S. gallon ~~to flow through the faucet after the handle or actuator is released.~~ per metering cycle at an 80 psig flowing supply pressure.

3. ‘Shower heads.’ The maximum discharge rate of shower heads shall be ~~3~~ 2.5 U.S. gallons per minute at an 80 psig flowing supply pressure.

4. ‘Sink faucets.’ The maximum discharge rate of sink faucets shall be ~~3~~ 2.2 U.S. gallons per minute at 80 psig flowing supply pressure.

5. ‘Urinals.’ Urinals shall function properly with a maximum of ~~4.5 one~~ U.S. ~~gallons~~ gallon per flush ~~per fixture use at static test pressures of 20 psig and 80 psig.~~ at an 80 psig flowing supply pressure.

6. ‘Urinal flushing devices.’ The flushing cycle for urinal flushing devices shall discharge a maximum of ~~4.5 one~~ U.S. ~~gallons~~ gallon per flush per fixture use at static test pressure of 20 psig and 80 psig.

7. ‘Water closets.’ Water closets shall function properly with a maximum of ~~4~~ 1.6 U.S. gallons per flush over the range of static test pressure specified in Table 84.20.

8. ‘Water closet flushing devices.’ The flushing cycle for water closet flushing devices shall discharge a maximum of ~~4~~ 1.6 U.S. gallons over the range of static test pressures specified in Table 84.20.

SECTION 99. Comm 84.20 (5) (b) 1. c., (n) 1. a. and b., (o) 1. a. and 2. b. and (p) 2. c. are amended to read:

**Comm 84.20 (5) (b) 1. c.** Plastic bathtubs shall conform to ~~ANSI Z124.1~~ ANSI Z124.1.2.

(n) 1. a. Vitreous china urinals shall conform to ASME A112.19.2M ~~and A112.19.6.~~

b. Plastic urinals shall conform to ANSI Z124.9 ~~and ASME A112.19.6.~~

(o) 1. a. Vitreous china water closets shall conform to ASME A112.19.2M ~~and A112.19.6.~~

2. b. Hinged, closed-front seats, without covers, which are encased with a continuous plastic sleeve capable of providing a clean surface for every user, ~~and for which a specific material approval under s. Comm 61.60 has been issued.~~

(p) 2. c. A drain valve shall be installed at the lowest point of each water heater and hot water storage tank. ~~Drain valves shall conform to ASSE 1005.~~

SECTION 100. Comm 84.20 (5) (o) 3. is repealed and recreated to read:

**Comm 84.20 (5) (o) 3. a.** Water closets provided in day care centers, individual living units or sleeping units of residential occupancies may be of a round-bowl type with a hinged, closed front seat with or without a cover.

**b.** Water closets provided in prisons or correctional institutions may be of a round-bowl type, with or without a seat or cover.

SECTION 101. Comm 84.30 (1) (f) note is repealed.

SECTION 102. Comm 84.30 (5) (c) 20. is created to read:

Comm 84.30 (5) (c) 20. Dual check backflow preventers in freeze resistant types of wall hydrants shall conform to ASSE 1053.

SECTION 103. Comm 84.30 Table 84.30–2 (partial), 84.30–5 (partial) and 84/30–6 (partial) are amended to read:

**Table 84.30–2  
(Partial Table)  
UNDERGROUND DRAIN AND VENT PIPE AND TUBING**

Material	Standard
Concrete	ASTM C14; ASTM C76
Vitrified clay	ASTM C700

**Table 84.30–5  
(Partial Table)  
PRESSURIZED DRAIN PIPE AND TUBING  
AND SERVICE SUCTION LINES**

Material	Standard
Ductile iron	ASTM A377; AWWA C115/A21.15 <del>AWWA C151/A21.51</del> AWWA C115; AWWA C151
Stainless steel	ASME B36.19M; ASTM A270 <del>A269</del> ; <del>A312/A312M</del> ; ASTM A450; A778; AWWA C220
Polyethylene (PE) Pressure Pipe and Tubing, ½ in through 3 in	AWWA C901–02

**Table 84.30–6  
(Partial Table)  
STORM BUILDING SEWER PIPE AND TUBING**

Material	Standard
Vitrified clay	ASTM C700

SECTION 104. Comm 84.30 (4) (e) 2. is amended to read:

**Comm 84.30 (4) (e) 2.** Cold water distribution pipe installed underground shall conform to one of the standards listed in Table 84.30–7 or 84.30–8 and shall have a minimum working pressure of 150 psig at 73.4°F.

SECTION 105. Comm 84.30 (4) (f) and (g) are repealed.

SECTION 106. Comm 84.30 (4) (h) is renumbered 84.30 (4) (f).

SECTION 107. Comm 84.30 Table 84.30–7 (partial), Table 84.30–8 (partial) and Table 84.30–10 (partial) are amended to read:

**Table 84.30–7  
(Partial Table)  
PIPE AND TUBING  
FOR WATER SERVICES AND PRIVATE WATER MAINS**

Material	Standard
Ductile iron	<del>ASTM A377; AWWA C115/A21.15 AWWA C151/A21.51</del> AWWA C115; AWWA C151
Polybutylene (PB)*	<del>ASTM D2662; ASTM D2666; ASTM D3000; ASTM D3309</del>
Polyethylene (PE) <sup>a</sup>	<del>ASTM D2239; ASTM D2737; ASTM D2104; ASTM D2447; ASTM D3035, AWWA C906 AWWA C901–02</del>

**Table 84.30–8  
(Partial Table)  
WATER DISTRIBUTION PIPE AND TUBING**

Material	Standard
Cast iron	<del>ASTM A377; AWWA C115/A21.15</del>
Ductile iron	<del>ASTM A377; AWWA C115/A21.15 AWWA C151/A21.51</del> AWWA C115; AWWA C151
Polybutylene (PB)*	<del>ASTM D3309</del>



**Table 84.30-10  
(Partial Table)  
PIPE FITTINGS**

Material	Standard
Ductile iron and gray iron	<del>ANSI/AWWA C110/A21.10</del> <del>ANSI/AWWA C153/A21.53</del> AWWA C110; AWWA C153; ANSI B16.42
Polybutylene (PB)*	ASTM D3309; MSS SP 103

SECTION 108. Comm 84.40 (2) (a) 2., (4) (b), (6) (a), (8) (c), (9) (b) and (10) (b) are amended to read:

**Comm 84.40 (2) (a) 2.** ‘Water supply systems.’ Mechanical push-on joints and mechanical compression-type joints for water supply systems which use a flexible elastomeric seal shall ~~conform to ASTM D3139~~ be suitable for potable water.

**(4) (b) Mechanical joints.** Mechanical joints shall be installed in accordance with the manufacturer’s instructions. Mechanical push-on joints and mechanical compression type joints for water supply systems which use flexible elastomeric seals shall ~~conform to ASTM D3139~~ be suitable for potable water.

**(6) (a) Mechanical joints.** Mechanical joints shall be installed in accordance with the manufacturer’s instructions. Mechanical push-on type joints which use flexible elastomeric seals shall ~~conform to ASTM D3139~~ be suitable for potable water.

**(8) (c) Mechanical joints.** Mechanical joints shall be installed in accordance with the manufacturer’s instructions. Mechanical push-on joints and mechanical compression type joints for water supply systems which use flexible elastomeric seals shall ~~conform to ASTM D3139~~ be suitable for potable water.

**(9) (a) Mechanical joints.** Mechanical push-on joints and mechanical compression type joints for water supply systems shall conform to AWWA C111/~~A21.11~~. Lead tipped gaskets may not be used.

**(10) (b) Mechanical joints.** Mechanical joints shall be installed in accordance with the manufacturer’s instructions. Mechanical push-on joints and mechanical compression type joints for water supply systems which use flexible elastomeric seals shall ~~conform to ASTM D3139~~ be suitable for potable water.

SECTION 109. Comm 84.40 (12) and (16) are repealed.

SECTION 110. Comm 84.40 (13) to (19) are renumbered 84.40 (12) to (18) and as renumbered 84.40 (12) (c), (14) (a) 2. and (15) (a) are amended to read:

**Comm 84.40 (12) (c) Mechanical joints.** Mechanical joints shall be installed in accordance with the manufacturer's instructions. Mechanical push-on joints and mechanical compression type joints which use flexible elastomeric seals shall ~~conform to ASTM D3139~~ be suitable for potable water.

**(14) (a) 2. 'Water supply systems.'** Mechanical push-on joints and mechanical compression type joints for water supply systems which use flexible elastomeric seals shall ~~conform to ASTM D3139~~ be suitable for potable water.

**(15) (a) Mechanical joints.** Mechanical joints shall be installed in accordance with the manufacturer's instructions. Mechanical push-on type joints which use flexible elastomeric seals shall ~~conform to ASTM D3139~~ be suitable for potable water.

**SECTION 111. Comm 82 Appendix is repealed and recreated to read:**

Chapter Comm 82  
APPENDIX

The material contained in this appendix is for clarification purposes only. The notes, illustrations, etc., are numbered to correspond to the number of the rule as it appears in the text of the code.

**A-82.20 (2) AGENT MUNICIPALITIES.** The department has designated 10 municipalities the authority to review and approve plumbing plans and specifications for those plumbing installations located within the boundary limits of the municipality and that require approval under s. Comm 82.20. The cities of Appleton, Eau Claire, Green Bay, Greenfield, Janesville, Madison, Milwaukee, Oshkosh, Sheboygan and West Bend have been designated as authorized municipalities. In addition, the cities of Eau Claire, Janesville, Madison and Sheboygan perform review of stormwater infiltration system plans.

**Note:** The department maintains a list on its web site at <http://commerce.wi.gov/SB> that is subject to change. See also the Plumbing Program page on the Safety and Buildings Division web site at <http://commerce.wi.gov/SB/SB-PlumbingProgram.html>.

**A-82.20 (4) WATER QUALITY MANAGEMENT AGENCIES (WQM.)** There are 23 water quality management agencies serving the state. These agencies review proposed sewer extensions and provide Sewer Service Area Conformance letters (also know as Water Quality Management letters).

**Note:** The department of natural resources maintains this WQM listing and may update it periodically. See <http://www.dnr.state.wi.us/org/water/wm/glwsp/facilities/rpc.htm> for a current list of agencies and the areas that they serve.

A-82.30 (4)-1. BRANCH INTERVALS.

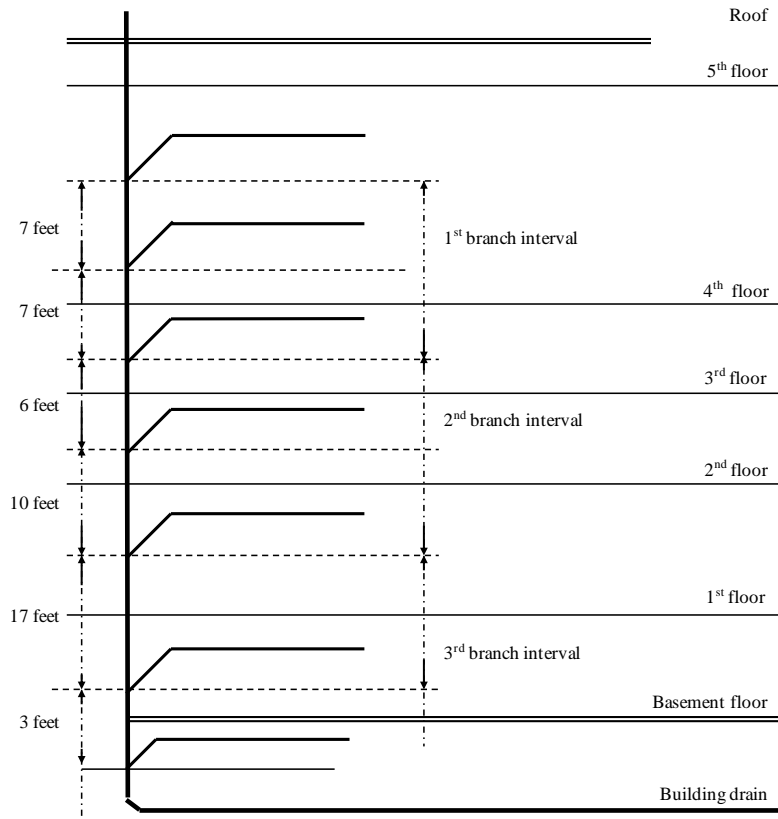

**A-82.30 (4)-2. RECEPTOR DESIGN.** The following table lists the gallons per minute (GPM) that can be expected to readily flow through a given size trap where the receptor has a height (H) as indicated.

Also listed is a drainage fixture unit (dfu) load that a given size receptor trap may be expected to adequately receive.

**Note:** A minimum individual 4 inch diameter trap and drain for a commercial type dishwasher is recommended.

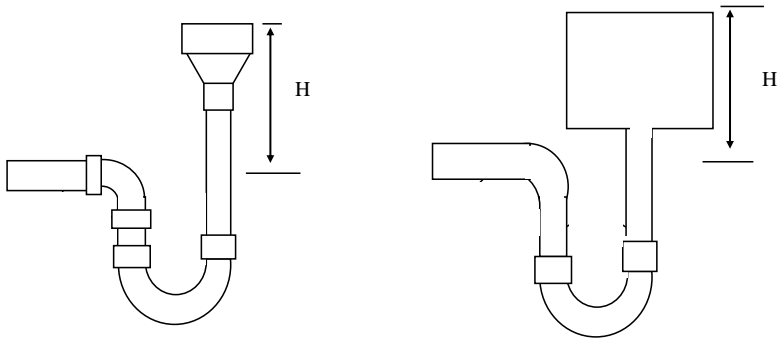

Receptor Trap Size (in inches)	H (in inches)	GPM	Drainage Fixture Units (dfu)
1½	12	4	2
2	14	8	4
3	15	12	6
4	17	40	20
5	20	70	35
6	22	120	60
8	25	250	125

**A-82.30 (4)-3. SLOPE BETWEEN MANHOLES IN CONVENTIONAL GRAVITY SEWERS.** Section NR 110.13 (2) (c) reads:

“*Slope.* 1. Conventional gravity sewers shall be laid with uniform slope between manholes. All sewers shall be designed and constructed to give average velocities of not less than 60 centimeters per second (2.0 feet per second) when flowing full. The minimum slopes in Table 1 shall be provided. Slopes less than 0.4% may be permitted for 20 centimeter (8 inch) sewers. In such cases, however, the slope may not be less than 0.3%. The department [DNR] will approve these sewers only when the owner demonstrates that physical circumstances warrant the lesser slope. Furthermore, approval will not be granted until the department [DNR] has received written assurance from the operating authority that the authority will provide the additional maintenance which may result from the sedimentation due to decreased velocities.”

**NR 110 Table 1**

Sewer Size (in inches)	Minimum Slope (ft./100 ft.)
8 (20 cm)	0.40
10 (25 cm)	0.28
12 (30 cm)	0.22
15 (38 cm)	0.15
18 (46 cm)	0.12
21 (53 cm)	0.10
24 (61 cm)	0.08

**A-82.30 (6) (b) OFFSETS IN VERTICAL DRAINS.**

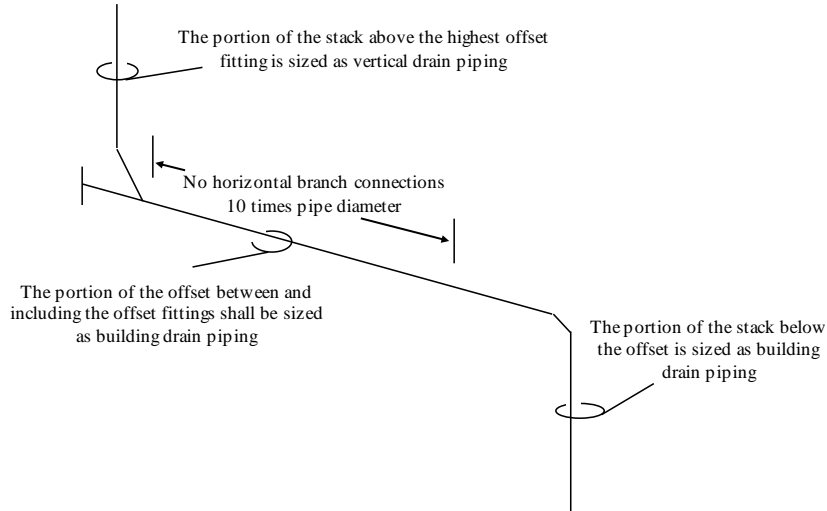

**A-82.30 (7) HORIZONTAL BRANCH DRAIN CONNECTION AT BASE OF A STACK.**

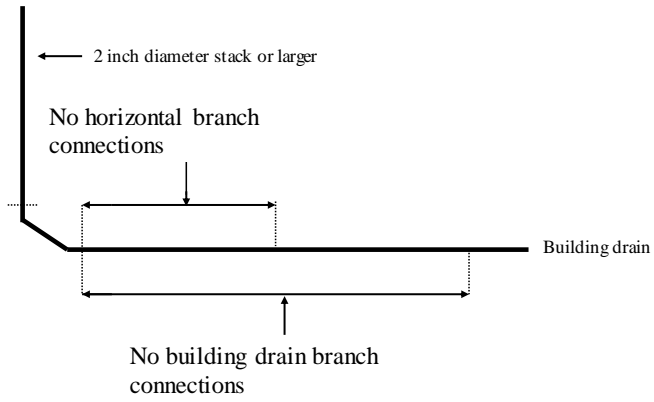

**A-82.30 (8) MEASURING RADIUS OF A FITTING.**

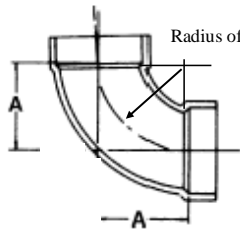

Radius of a plastic DWV fitting

Radius of hub and spigot fitting

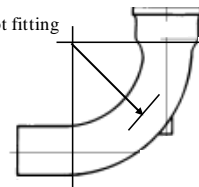

**A-82.30 (10)(a) DETERMINING REQUIRED CAPACITY OF SANITARY SUMP.**

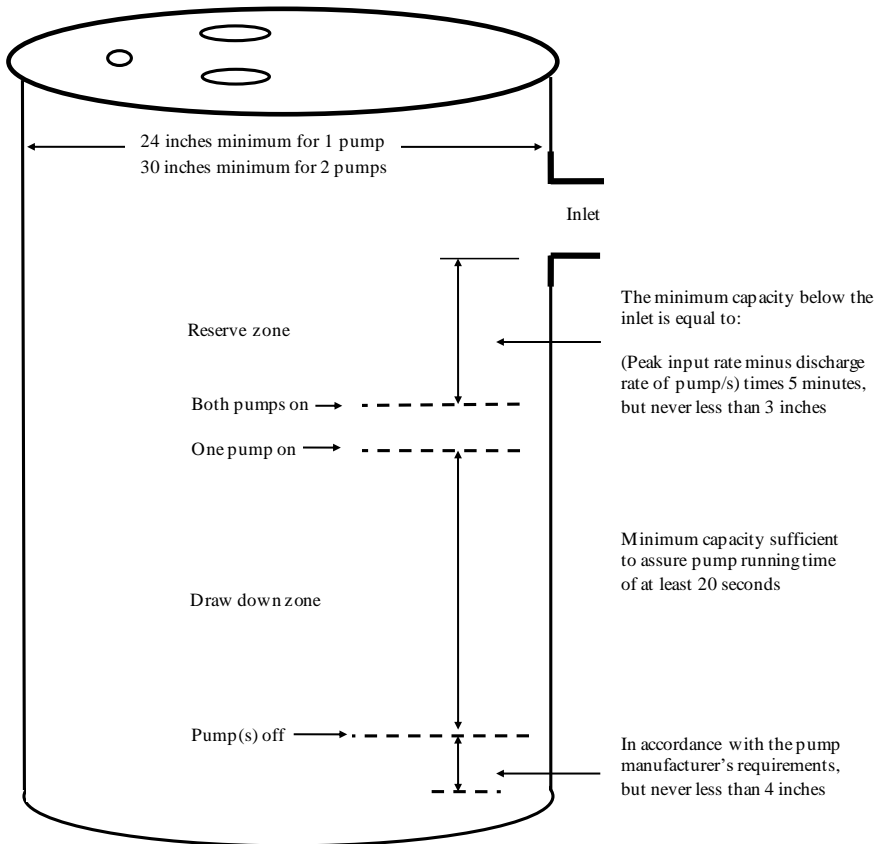

**A-82.30 (10) (a) SUMPS.**

**Capacity of Sumps  
(in gallons)**

Diameter of sump in inches	Volume in gal/ft	Diameter of sump in inches	Volume in gal/ft
24	23.5	41	68.6
25	25.5	42	72.1
26	27.6	43	75.5
27	29.7	44	79.1
28	32.0	45	82.7
29	34.3	46	86.5
30	36.8	47	90.2
31	39.2	48	94.0
32	41.8	54	119.0
33	44.5	60	147.0
34	47.2	66	178.0
35	50.0	72	211.5
36	52.8	78	248.4
37	55.9	84	288.1
38	59.0	90	330.8
39	62.1	96	376.3
40	65.3	108	477.3

**A-82.30 (10) (b) 3. VELOCITY AND FLOW RELATIONSHIP MAINTAINING 2 FEET PER SECOND.**

**Schedule 40 PVC**

**VELOCITY AND FLOW RELATIONSHIP  
MAINTAINING 2 FEET PER SECOND**

Nominal Inside Diameter (in inches)	Actual Inside Diameter (in inches)	GPM creating 2 ft. per second
1¼	1.38	9
1½	1.61	13
2	2.067	21
3	3.068	46
4	4.026	79



**A-82.30 (11) (b) BUILDING DRAINS SERVING ANY BUILDING.**

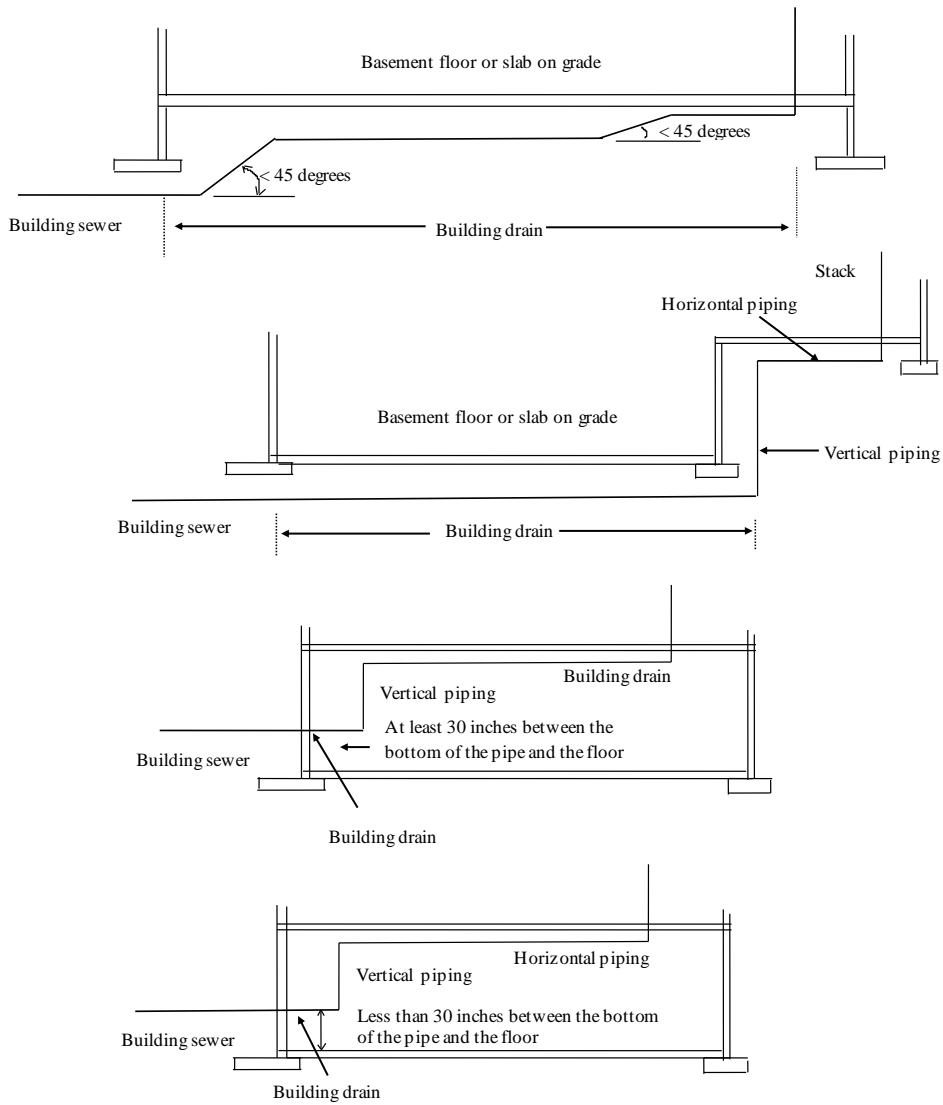

**A-82.30 (11) (c) BUILDING SEWER INSULATION.**

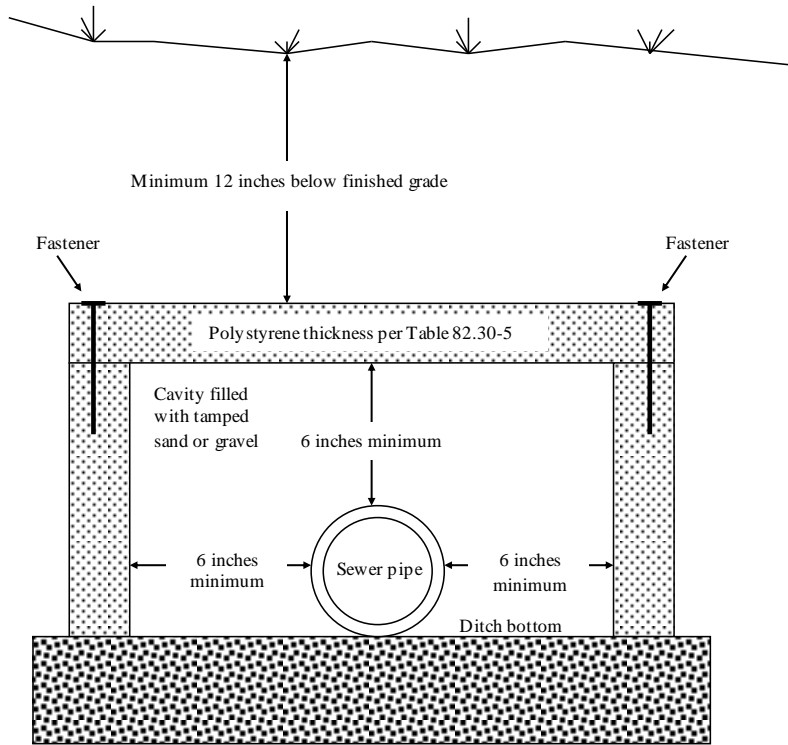

**A-82.30 (11) (d) SETBACKS FOR VARIOUS CONTAMINANT SOURCES.** Setbacks for various contaminant sources as specified in chs. NR 811 and NR 812 read:

**NR 811.16 (4) (d)** The well shall be adequately separated from potential sources of contamination. Unless a hydrogeologic investigation indicates lesser separation distances would provide adequate protection of a well from contamination, the minimum separation distances provided shall be:

1. Fifty feet between a well and a storm sewer main.
2. Two hundred feet between a well and any sanitary sewer main, sanitary sewer manhole, lift station or single family residential fuel oil tank. A lesser separation distance may be allowed for sanitary sewer mains where the sanitary sewer main is constructed of water main materials and joints and pressure tested in place to meet current AWWA C600 specifications. In no case may the separation distance between a well and a sanitary sewer main be less than 50 feet.
3. Four hundred feet between a well and a septic tank or soil adsorption unit receiving less than 8,000 gallons per day, a cemetery or a storm water drainage pond.
4. Six hundred feet between a well and any gasoline or fuel oil storage tank installation that has received written approval from the department of commerce or its designated agent under s. Comm 10.10.
5. One thousand feet between a well and land application of municipal, commercial or industrial waste; the boundaries of a landspreading facility for spreading of petroleum-contaminated soil regulated under ch. NR 718 while that facility is in operation; industrial, commercial or municipal waste water lagoons or storage structures; manure stacks or storage structures; and septic tanks or soil adsorption units receiving 8,000 gallons per day or more.
6. Twelve hundred feet between a well and any solid waste storage, transportation, transfer, incineration, air curtain destructor, processing, wood burning, one time disposal or small demolition facility; sanitary landfill; any property with residual groundwater contamination that exceeds ch. NR 140 enforcement

standards that is shown on the department's geographic information system registry of closed remediation sites; coal storage area; salt or deicing material storage area; gasoline or fuel oil storage tanks that have not received written approval from the department of commerce or its designated agent under s. Comm 10.10; bulk fuel storage facilities; and pesticide or fertilizer handling or storage facilities.

**Note:** Sites that have been closed with groundwater enforcement standard exceedances can be found on the Department of Natural Resource's GIS Registry of Closed Remediation Sites, at <http://www.dnr.state.wi.us/org/aw/rr> on the DNR's internet site. Information that appears on the GIS Registry of Closed Remediation Sites can also be accessed by calling the nearest regional DNR office.

**NR 812.08 Well, reservoir and spring location. (1) GENERAL.** Any potable or nonpotable well or reservoir shall be located:

- (a) So the well and its surroundings can be kept in a sanitary condition.
- (b) At the highest point on the property consistent with the general layout and surroundings if reasonably possible, but in any case protected against surface water flow and flooding and not downslope from a contamination source on the property or on an adjacent property regardless of what was installed first, the well or the contamination source. When a contamination source is installed upslope from a well in violation of this section after the well construction has been completed, the violation is not the responsibility of the well driller, except if the well driller knew or should have known of the proposed upslope installation of the contamination source. When there is no location on the property where this requirement can be met, a well may be constructed without a variance if it is constructed with a minimum of 20 or more feet of well casing pipe than is required by ss. NR 812.12 and 812.13 and Tables I and II or with a minimum of 60 feet of well casing pipe provided that the minimum well casing pipe depth requirements of s. NR 812.12 or 812.13 and Table I or II are met. This exception does not apply to high capacity, school or wastewater treatment plant wells. A well or reservoir is located downslope from a contamination source, regardless of the presence or absence of a structure between the well and the contamination source, if:
  1. The ground surface elevation at the well or reservoir is lower than the elevation at the contamination source, and
  2. Surface water that washes over the contamination source would travel within eight feet of the well or reservoir, or over the well or reservoir.
- (c) As far away from any known or possible source of contamination as the general layout of the premises and the surroundings allow.

**Note:** Section PSC 114.234 C8 requires that a horizontal clearance of at least  $\frac{3}{4}$  of the vertical clearance of the conductors, including overhead power lines to the ground required by Rule 232 shall be maintained between open conductors and wells. Persons installing wells must comply with this requirement.

- (d) Such that any potential contaminant source, not identified in this section or in Table A, is a minimum of 8 feet from the well or reservoir.
- (e) Every well shall be located so that it is reasonably accessible with proper equipment for cleaning, treatment, repair, testing, inspection and any other maintenance that may be necessary.

**(2) RELATION TO BUILDINGS.** In relation to buildings, the location of any potable or nonpotable well shall be as follows:

- (a) When a well is located outside and adjacent to a building, it shall be located so that the center line of the well extended vertically will clear any projection from the building by not less than 2 feet and so that the top of the well casing pipe extends at least 12 inches above the final established ground grade.
- (b) When a structure is built over a drilled well, it shall have an access hatch or removable hatch, or provide other access to allow for pulling of the pump. The well casing pipe shall extend at least 12 inches above the floor and be sealed watertight at the point where it extends through the floor.
- (c) No well may be located, nor a building constructed, such that the well casing pipe will terminate in or extend through the basement of any building or terminate under the floor of a building having no basement. The top of a well casing pipe may terminate in a walkout basement meeting the criteria of s. NR 812.42 (9) (b) 1. to 4. A well may not terminate in or extend through a crawl space having a below ground grade depression or excavation.

**(3) RELATION TO FLOODPLAINS.** (a) A potable or nonpotable well may be constructed, reconstructed or replaced in a floodfringe provided that the top of the well is terminated at least 2 feet above the regional flood elevation for the well site.

(b) A well may be reconstructed or replaced in a floodway provided that the top of the well is terminated at least 2 feet above the regional flood elevation for the well site.

(c) A well may not be constructed on a floodway property that is either undeveloped or has building structures but no existing well.

(d) The regional flood elevation may be obtained from the department.

(4) **RELATION TO CONTAMINATION SOURCES.** Minimum separating distances between any new potable or nonpotable well, reservoir or spring and existing sources of contamination; or between new sources of contamination and existing potable or nonpotable wells, reservoirs or springs shall be maintained as described in this subsection. The minimum separating distances of this subsection do not apply to dewatering wells approved under s. NR 812.09 (4) (a). Greater separation distances may be required for wells requiring plan approval under s. NR 812.09. Separation distance requirements to possible sources of contamination will not be waived because of property lines. Minimum separating distances are listed in Table A and are as follows:

(a) Eight feet between a well or reservoir and a:

1. Buried gravity flow sanitary or storm building drain having pipe conforming to ch. Comm 84;
2. Buried gravity flow sanitary or storm building sewer having pipe conforming to ch. Comm 84;
3. Watertight clear water waste sump;
4. Buried clear water waste drain having pipe conforming to ch. Comm 84;
5. Buried gravity flow foundation drain;
6. Rainwater downspout outlet;
7. Cistern;
8. Buried building foundation drain connected to a clear water waste drain or other subsoil drain;
9. Noncomplying pit, subsurface pumproom, alcove, or reservoir;
10. Nonpotable well;
11. Fertilizer or pesticide storage tank with a capacity of less than 1,500 gallons, but only when the well is nonpotable;

**Note:** For potable wells see par. (d) 1.

12. Plastic silage storage and transfer tube;
13. Yard hydrant;
14. Swimming pool, measured to the nearest edge of the water; or
15. Dog or other small pet house, animal shelter or kennel housing not more than 3 adult pets on a residential lot.

(b) Twenty-five feet between a well or reservoir and a:

1. Buried grease interceptor or trap;
2. Septic tank;
3. Holding tank;
4. Buried building drain or building sewer having pipe not conforming to ch. Comm 84, wastewater sump, or non-watertight clear water waste sumps;
5. Buried pressurized sanitary building sewer having pipe conforming to ch. Comm 84;
6. Buried gravity manure sewer;
7. Lake, river, stream, ditch or stormwater detention pond or basin measured to the regional high water elevation in the case of a lake or stormwater detention pond, to the edge of the floodway in the case of a river or stream or to the edge in the case of a ditch or stormwater detention basin;
8. Liquid-tight bam gutter;
9. Animal bam pen with concrete floor;
10. Buried pressurized sewer pipe conveying manure provided that the pipe meets ASTM specification D-2241, with standard dimension ratio of 21 or less or pressure pipe meeting the requirements of s. NR 110.13 (6) (f) or 811.62.

**Note:** There is no NR 110.13 (6) (f).

11. Buried fuel oil tanks serving single family residences, including any associated buried piping;
12. Discharge to ground from a water treatment device;
13. Vertical shaft installed below grade used for intake of air for a heating or air conditioning system; or
14. Buried sanitary or storm collector sewer serving 4 or fewer living units or having a diameter of 6 inches or less.
15. (c) Fifty feet between a well or reservoir and a:

16. Soil absorption unit receiving less than 8,000 gallons/day, existing, abandoned or alternate, but not including a school soil absorption unit;

**Note:** For school soil absorption units see par. (e); for soil absorption units receiving more than 8,000 gallons/day see par. (f) 3.

1. Privy;
2. Pet waste pit disposal unit;
3. Animal shelter;
4. Animal yard;
5. Silo;
6. Buried sewer used to convey manure having pipe conforming to ch. Comm 84 that does not meet the specifications in par. (b);
7. Liquid-tight manure hopper or reception tank;
8. Filter strip;
9. Buried sanitary or storm collector sewer serving more than 4 living units or larger than 6 inches in diameter except that wells may be located or sewers installed such that a well is less than 50 feet, but at least 25 feet, from gravity collector sewers smaller than 16 inches in diameter or from force main collector sewers 4 inches or smaller in diameter provided that within a 50-foot radius of the well the installed sewer pipe meets the allowable leakage requirements of AWWA C600 and the requirements for water main equivalent type pipe as follows:
  - a. For sewers > 4", diameter, but < 16", diameter: PVC pipe > 4", diameter, but < 12", diameter shall meet AWWA C900 with elastomeric joints having a standard dimension ratio of 18 or less; PVC pipe > 12", diameter, but < 16", diameter shall meet AWWA C905 with elastomeric joints having a standard dimension ratio of 18 or less; Ductile iron pipe shall meet AWWA C115 or AWWA C151 having a thickness class 50 or more.
  - b. For sewers < 3", diameter, the pipe shall be any rigid pipe in the ch. Comm 84 "Table for Pipe and Tubing for Water Services and Private Water Mains," including approved ABS, brass, cast iron, CPVC, copper (not including type M copper) ductile iron, galvanized steel, polybutylene (PB), polyethylene (PE), PVC, or stainless steel pipe.
10. An influent sewer to a wastewater treatment plant;
11. The nearest existing or future grave site in cemeteries;
12. Wastewater treatment plant effluent pipe;
13. Buried pressurized sewer having pipe not conforming to ch. Comm 84; or
14. Manure loading area.

**Note:** The minimum separating distance between a well or reservoir and a lift station is based on the presence of a sewer force main at the lift station.

(d) One hundred feet between a well or reservoir and a:

1. Bulk surface storage tank with a capacity greater than 1,500 gallons or any bulk buried storage tank regardless of capacity, including, for both surface or buried tanks, associated buried piping for any solid, semi-solid or liquid product but not including those regulated under par. (b) 12. This subdivision includes, but is not limited to petroleum product tanks, waste oil tanks and pesticide or fertilizer storage tanks not regulated under par. (a) 11. This subdivision does not include septic, holding and manure reception tanks, or liquified petroleum gas tanks as specified in ch. Comm 11.
2. Liquid-tight, fabricated manure or silage storage structure, in ground or at ground surface;
3. Wastewater treatment plant structure, conveyance or treatment unit; or
4. Dry fertilizer or pesticide storage building or area when more than 100 pounds of either or both materials are stored;
5. Well, drillhole or water system used for the underground placement of any waste, surface or subsurface water or any substance as defined in s. 160.01 (8), Stats.;
6. Stormwater infiltration basin;
7. Uncovered storage of silage on the ground surface;
8. Water-tight silage storage trench or pit; or
9. Lift station.

(e) Two hundred feet between a school well and a soil absorption unit receiving less than 8,000 gallons per day, existing or abandoned.

(ee) One hundred fifty feet between a well or reservoir and a temporary manure stack.

(f) Two hundred fifty feet between a well or reservoir and a:

1. Manure stack.

2. Earthen or excavated manure storage structure.

**Note:** Variances from the separating distances may be granted as specified in s. NR 812.43 for earthen storage and manure stacks constructed and maintained to the specifications of Soil Conservation Standards No. 425 or 312, respectively.

3. Soil absorption unit receiving 8,000 or more gallons per day, existing, abandoned, or alternate.
4. Sludge landspreading or drying area.
5. An earthen silage storage trench or pit.
6. Liquid waste disposal system including, but not limited to a treatment pond or lagoon, ridge and furrow system and spray irrigation system.

**Note:** Variance from this separating distance may be granted for treatment ponds or lagoons constructed and maintained to an approval granted under ch. NR 213.

7. Salvage yard.
  8. A salt or deicing material storage area including the building structure and the surrounding area where the material is transferred to vehicles. This subdivision does not include bagged deicing material.
  9. Solid waste processing facility.
  10. Solid waste transfer facility.
  11. The boundaries of a landspreading facility for spreading of petroleum-contaminated soil regulated under ch. NR 718 while that facility is in operation.
- (g) Twelve hundred feet between a well or reservoir and:
1. The nearest edge of the limits of filling of an existing, proposed or abandoned landfill, measured to the nearest fill area of abandoned landfills, if known. Otherwise measured to the nearest property line where the landfill is located. The department may require, as part of a variance request, a land survey map, a scaled diagram of the landfill and the well location, or another accurate measurement method to determine and demonstrate the distance between the landfill and the well;
  2. The nearest edge of a coal storage area in excess of 500 tons; or
  3. A hazardous waste treatment facility regulated by the department

**A-82.30 (11)(f) CONNECTION TO PRESSURIZED PUBLIC SEWER.**

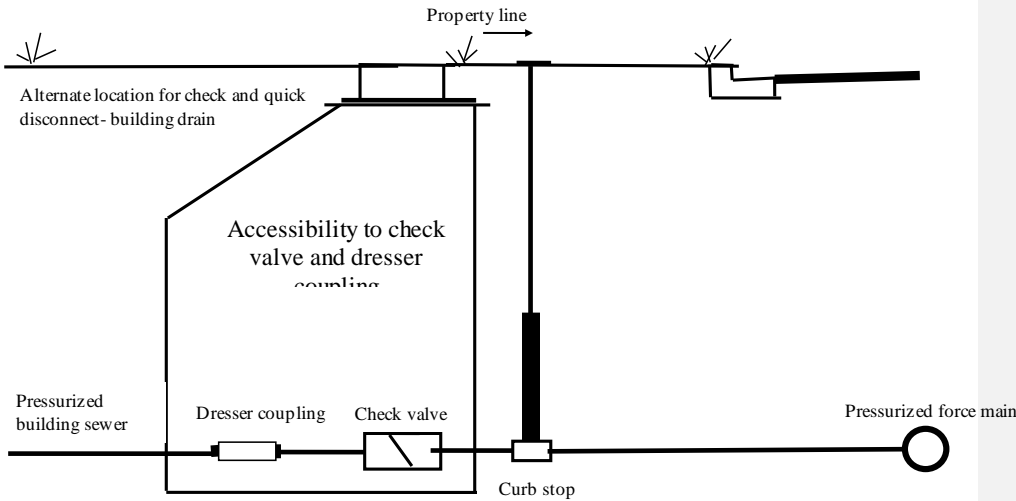

A-82.31 (4)-1. WHERE A VENT STACK AND STACK VENT ARE REQUIRED.

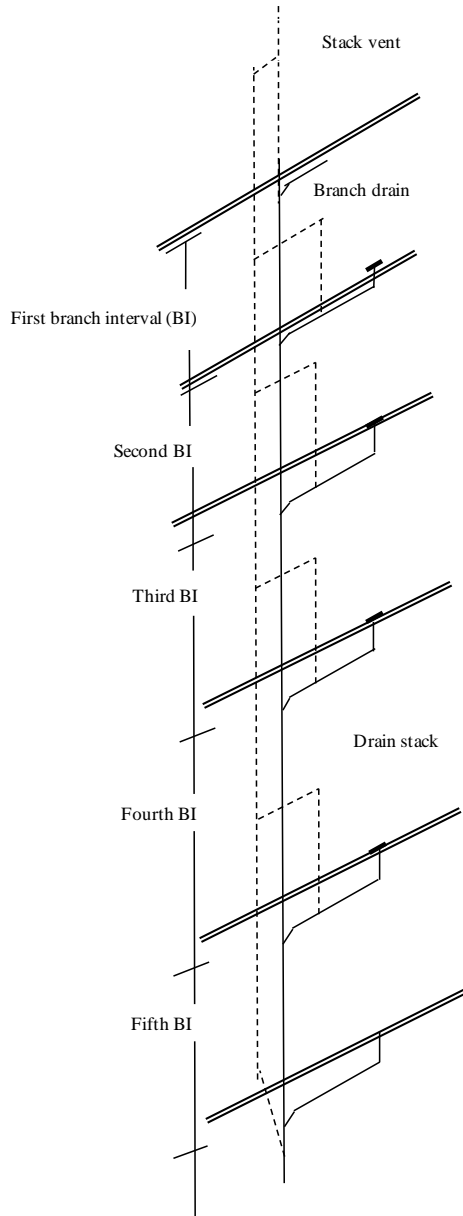

**A-82.31 (4)-2. INSTALLATION OF VENT STACK AND STACK VENT.**

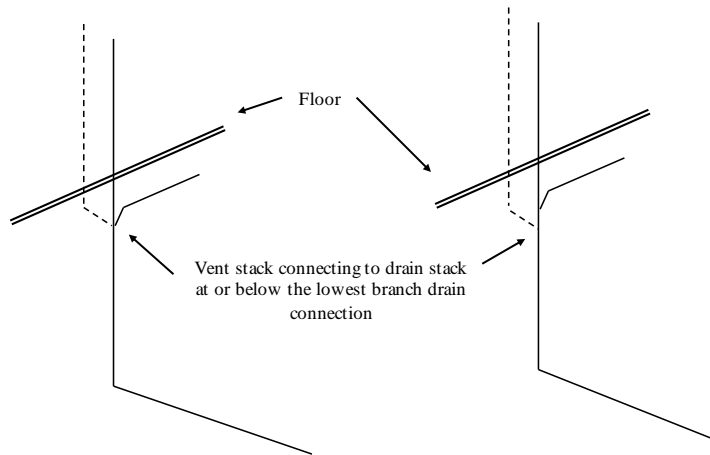

**A-82.31 (5) (a) VENTING OFFSETS OF 30 TO 45 DEGREES.**

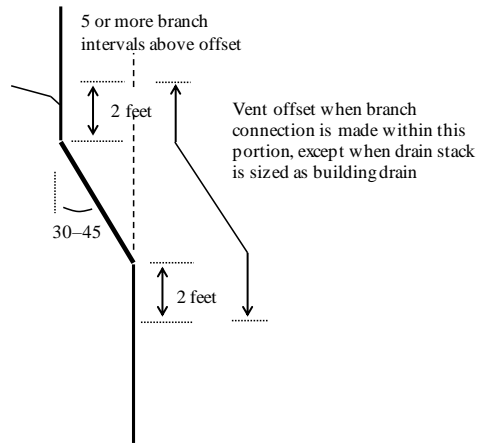



**A-82.31 (5) (b) VENTS FOR OFFSETS OF MORE THAN 45 DEGREES.**

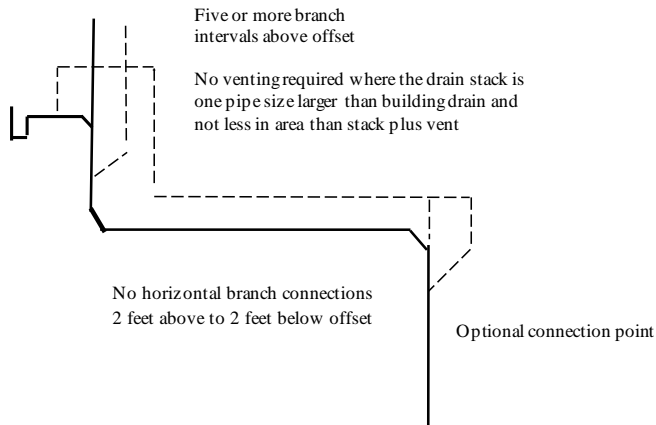

**A-82.31 (7) RELIEF VENTS FOR BUILDING DRAINS.**

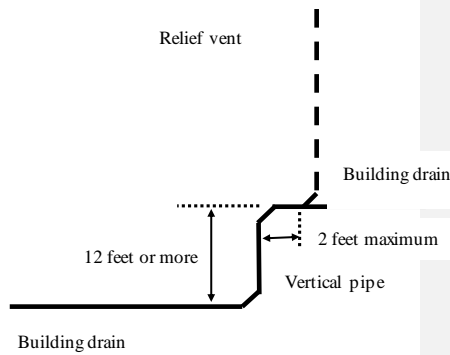
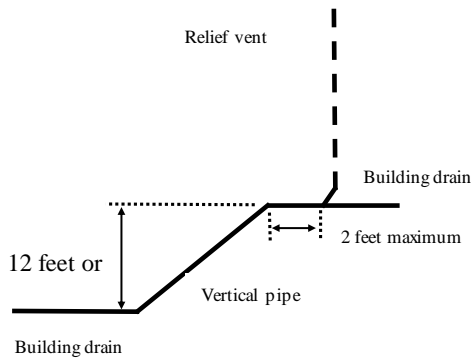

A-82.31 (9) FIXTURE VENTS.

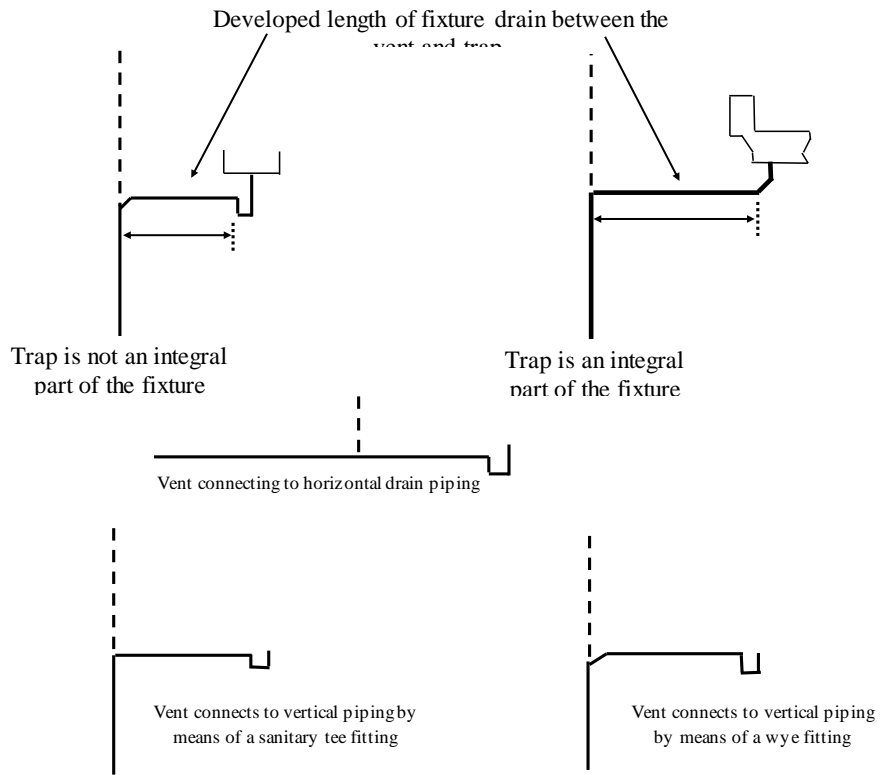

A-82.31 (10)-1. CIRCUIT VENTING.

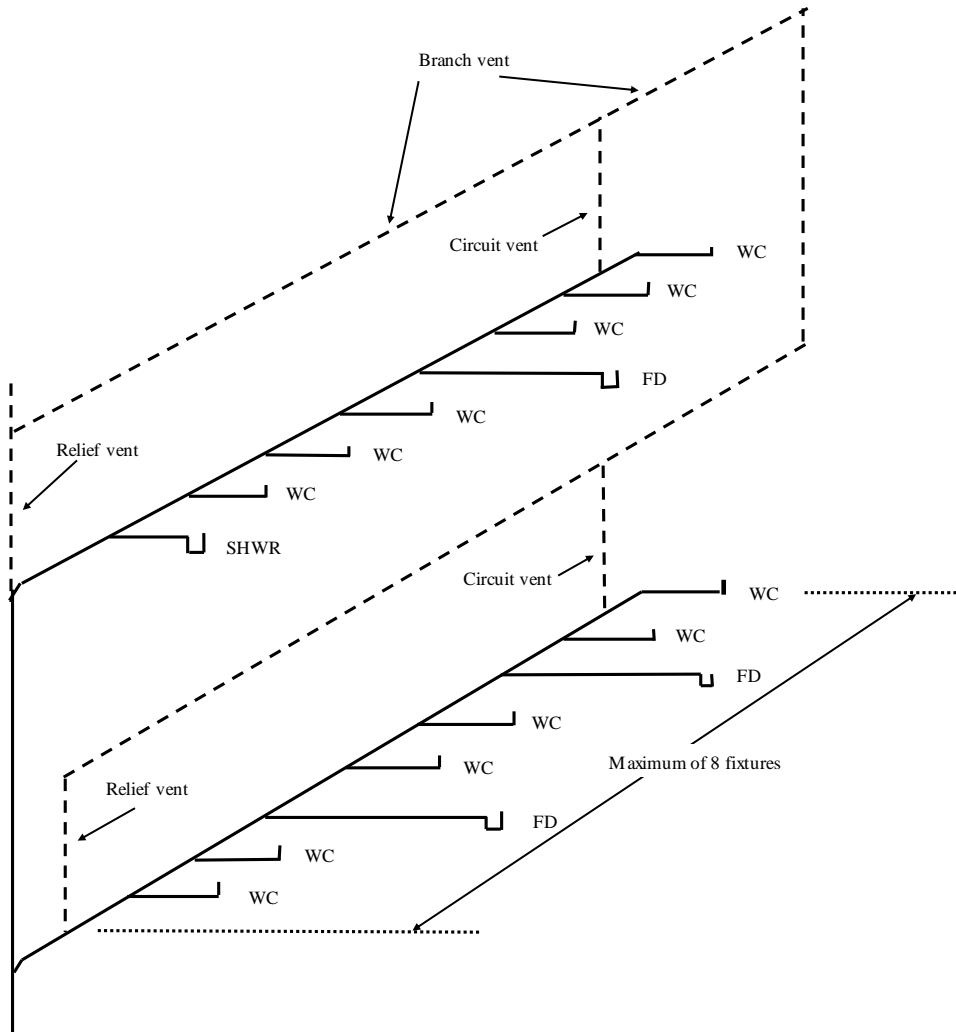

A-82.31 (10)-2. CIRCUIT VENTING.

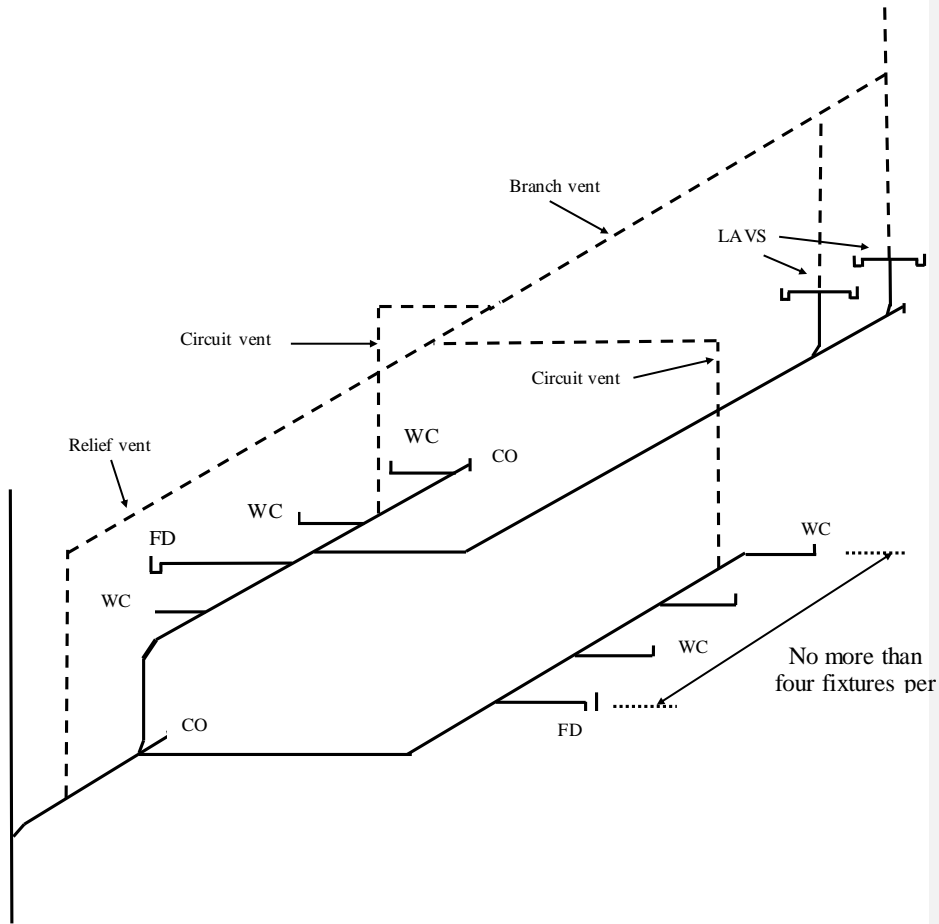

A-82.31 (10)-3. CIRCUIT VENTING.

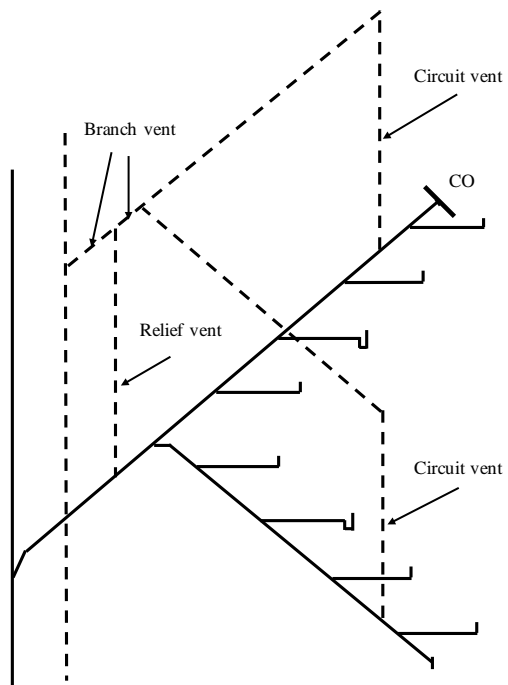

A-82.31 (10)-4. CIRCUIT VENTING

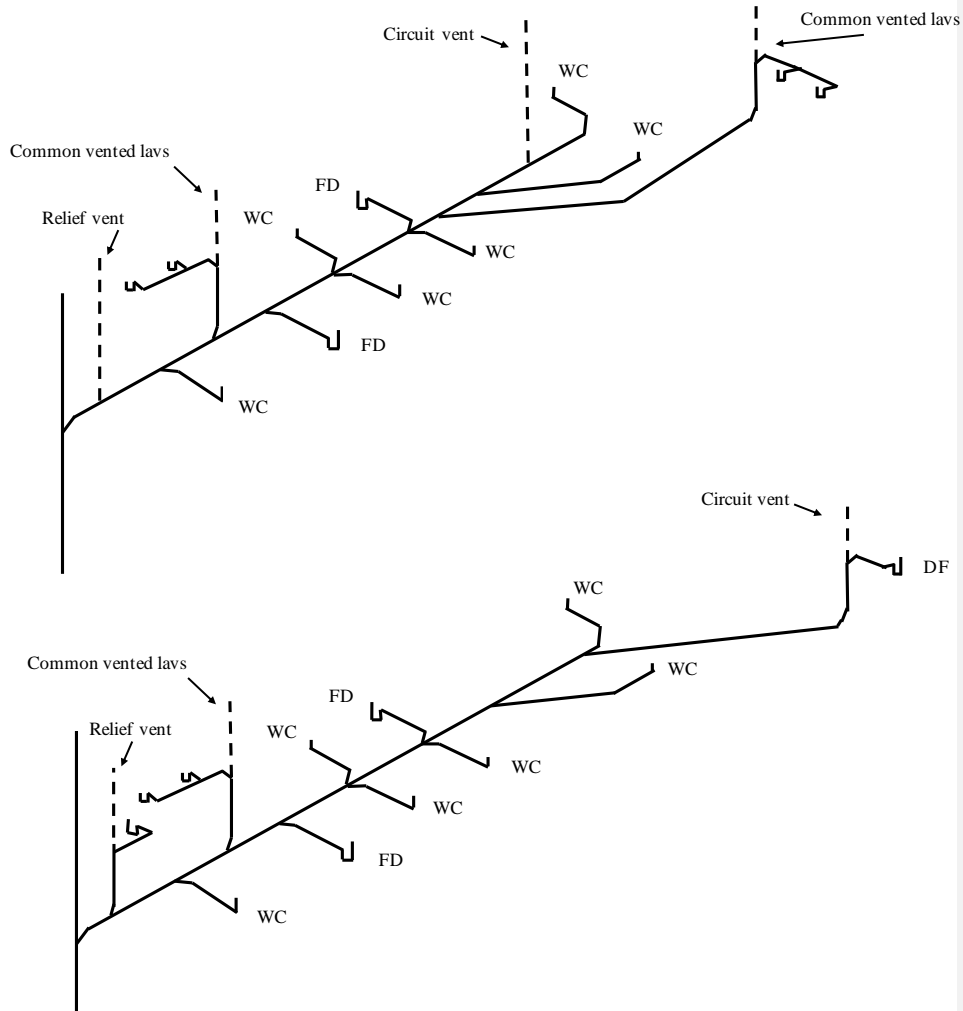

**A-82.31 (11) (a) COMMON VENTS, VERTICAL, SERVING ANY TWO FIXTURES.**

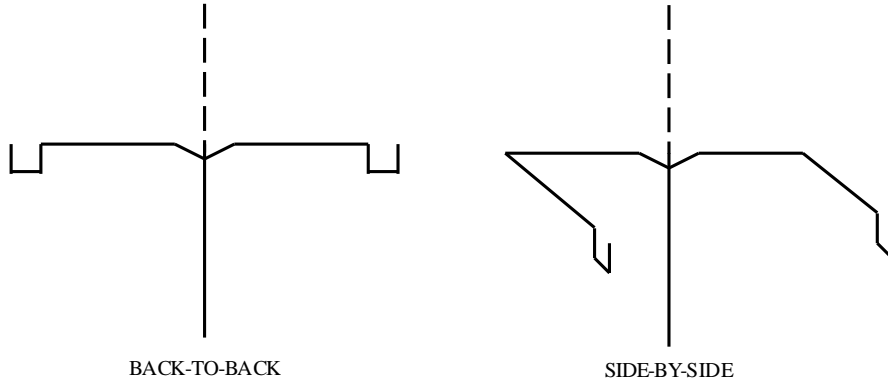

**A-82.31 (11) (b) COMMON VENTS, HORIZONTAL DRAINS.**

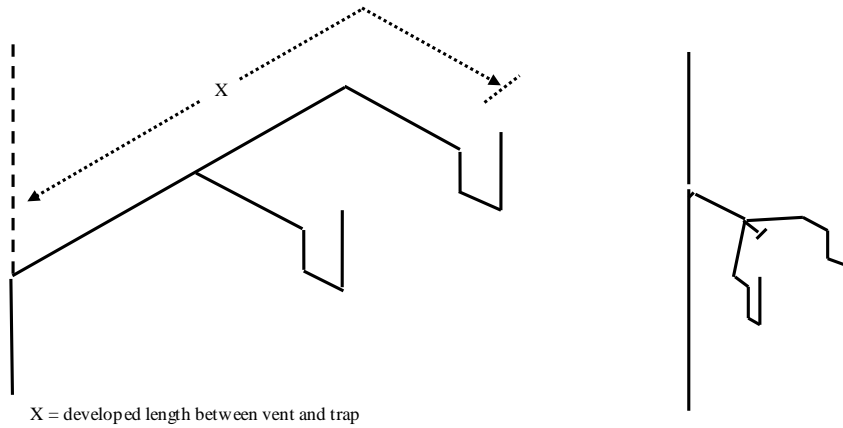

**A-82.31 (12) RETURN VENTS.**

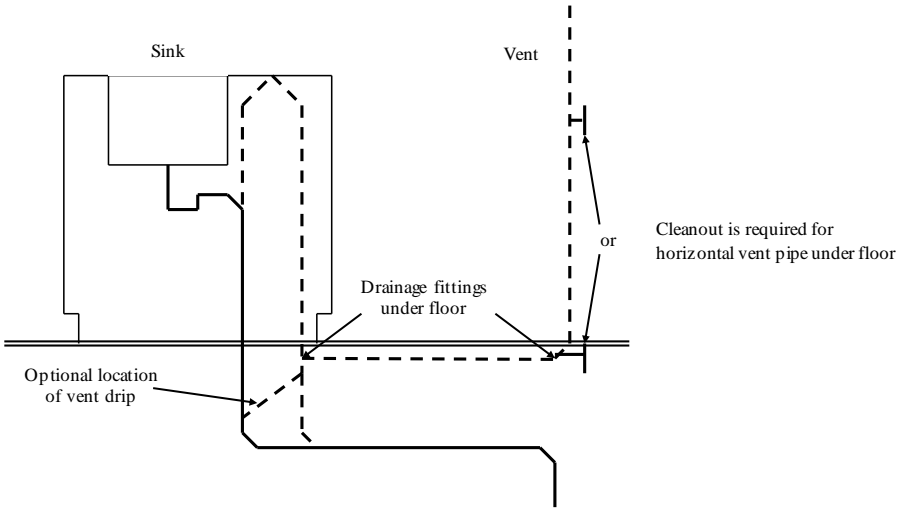

**A-82.31 (13)(a) VERTICAL WET VENTS.**

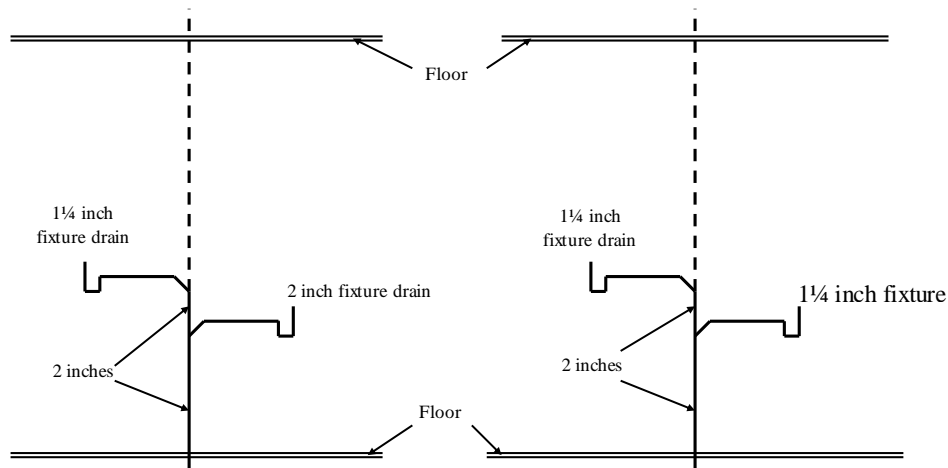



A-82.31 (13)-1. HORIZONTAL WET VENTS.

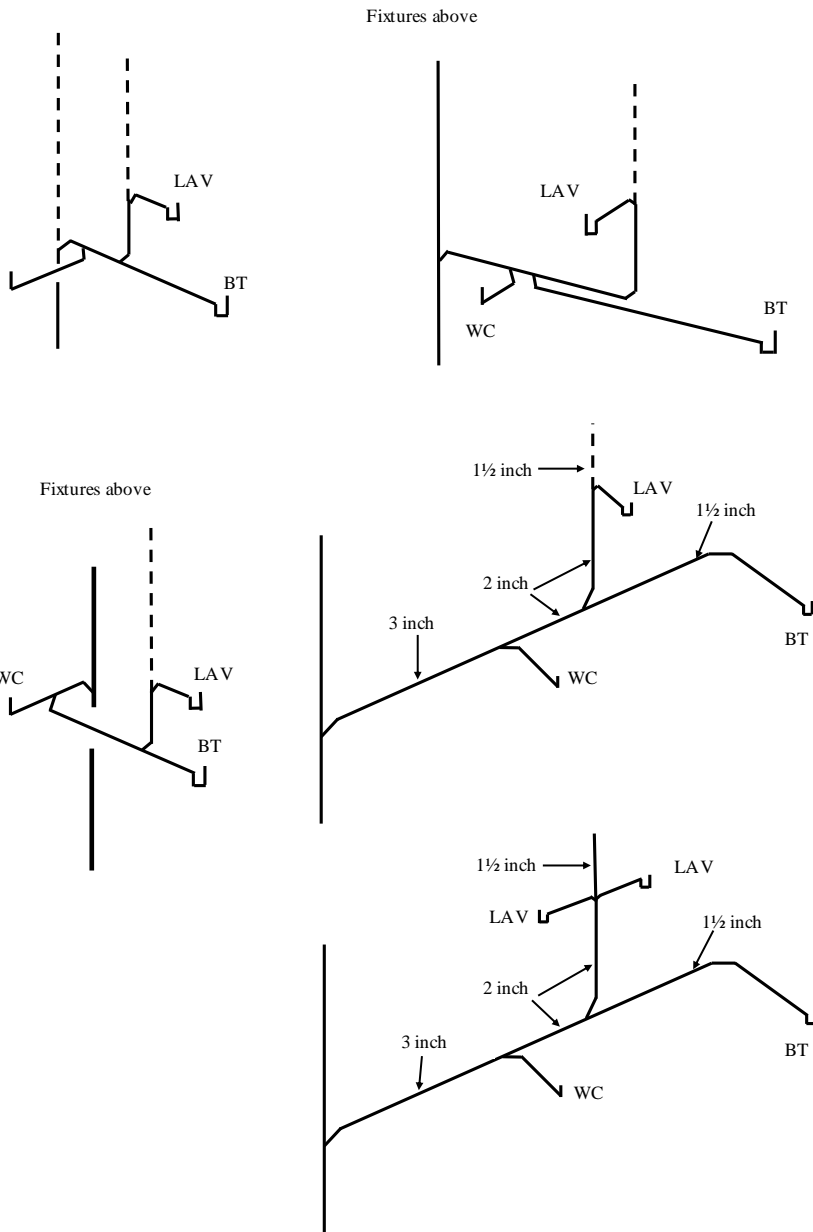

A-82.31 (13)-2. WET VENTING – FLOOR OUTLET FIXTURES.

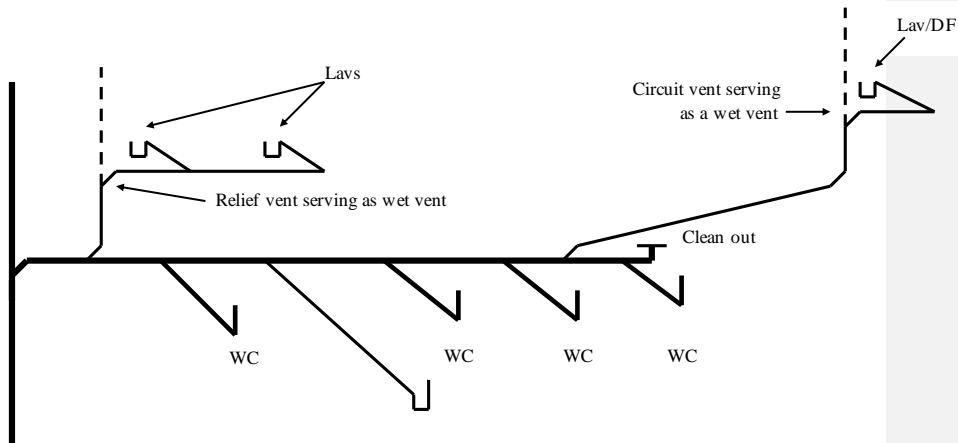
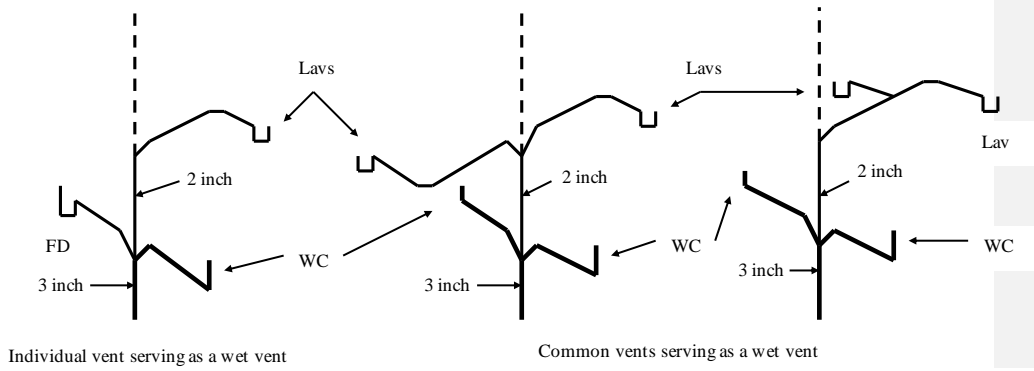
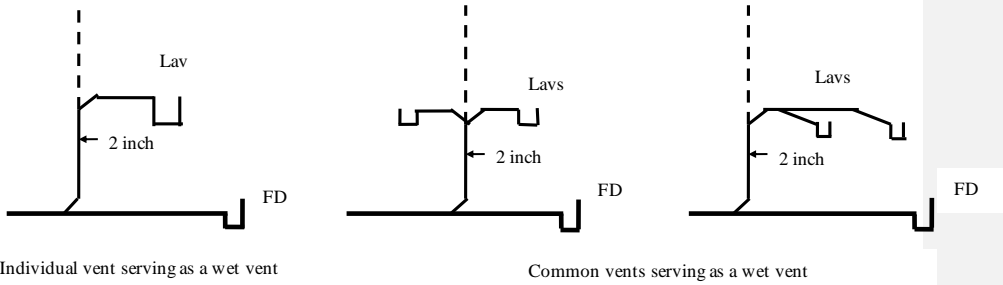

**A-82.31 (14) (a) and (b) SIZING VENT STACKS AND STACK VENTS**

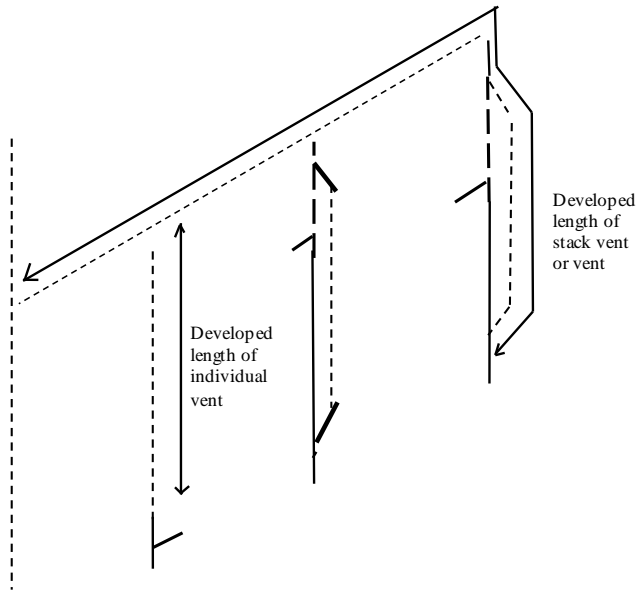

**A-82.31 (14) (c) SIZING BRANCH VENTS SERVING A WET VENT.**

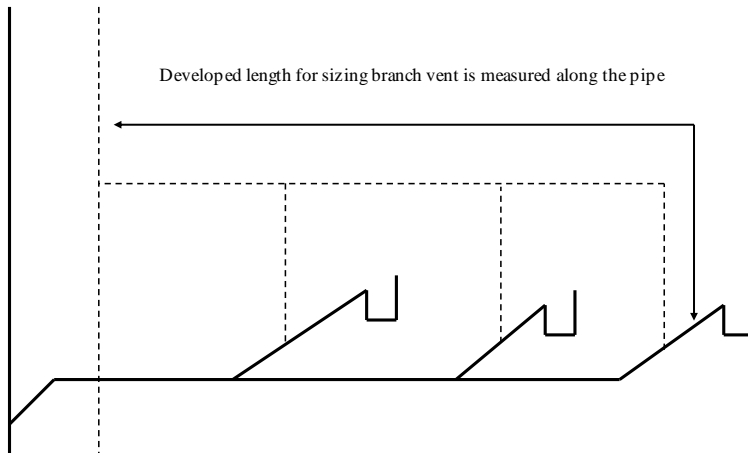

A-82.31 (14)(d) SIZING INDIVIDUAL VENTS.

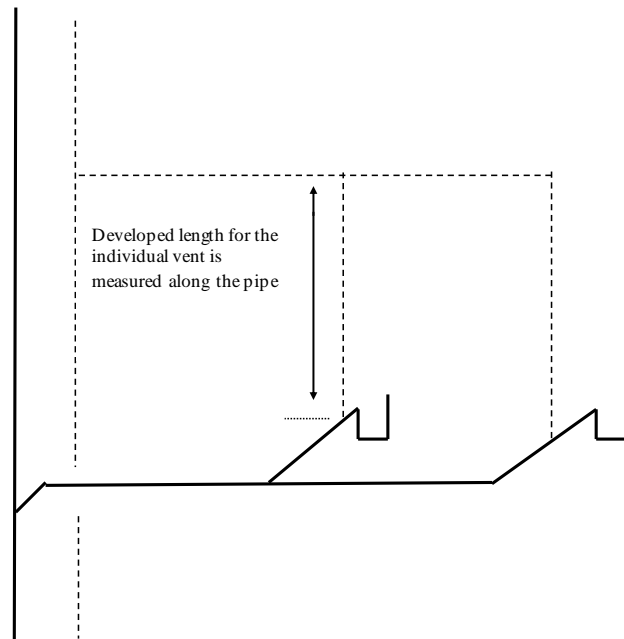
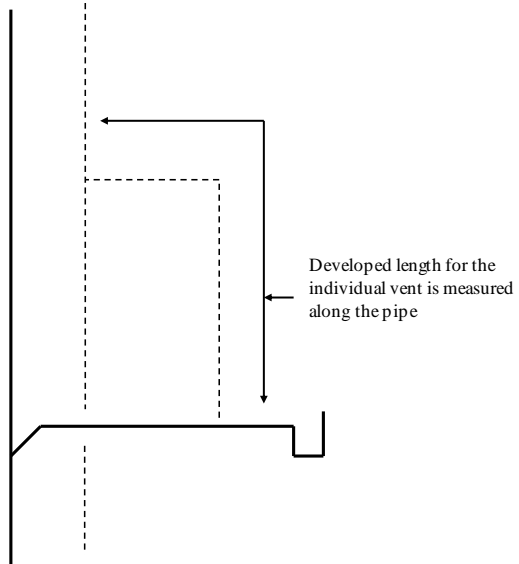

A-82.31 (15) (a) VENT GRADES AND CONNECTIONS.

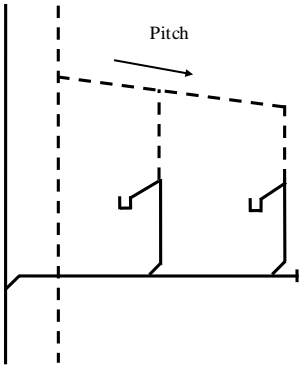

WHEREVER POSSIBLE

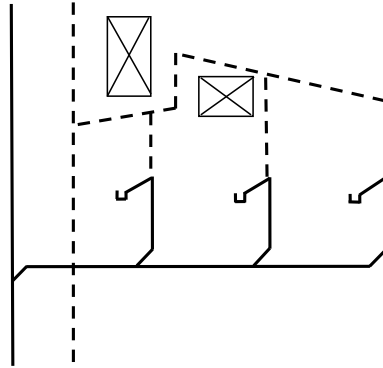

MAY BE ALLOWED WHERE CONDITIONS DICTATE

A-82.31 (15) (b) VENT GRADES AND CONNECTIONS.

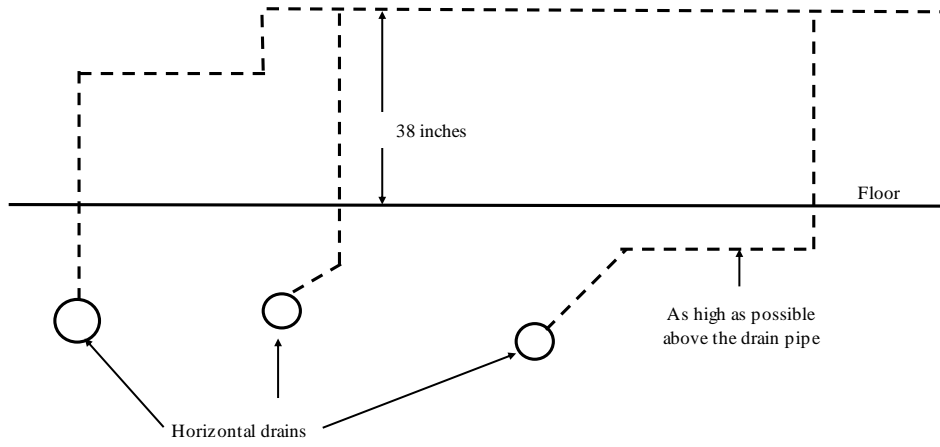

A-82.31 (16) VENT TERMINALS.

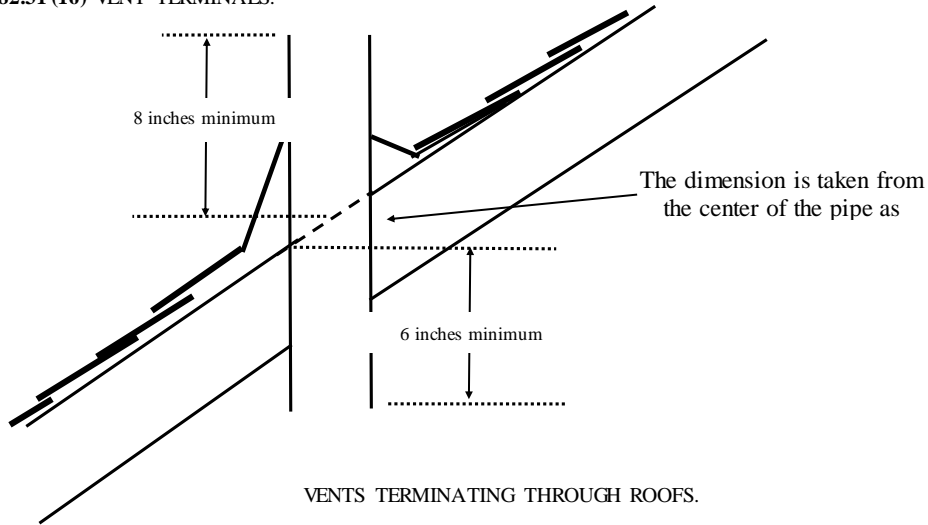

VENTS TERMINATING THROUGH ROOFS.

A-82.31 (16) VENT TERMINALS.

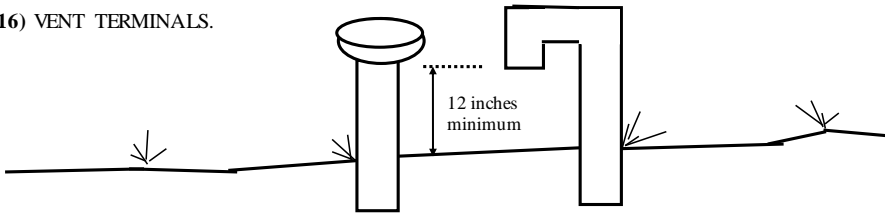

VENTS TERMINATING AT GRADE

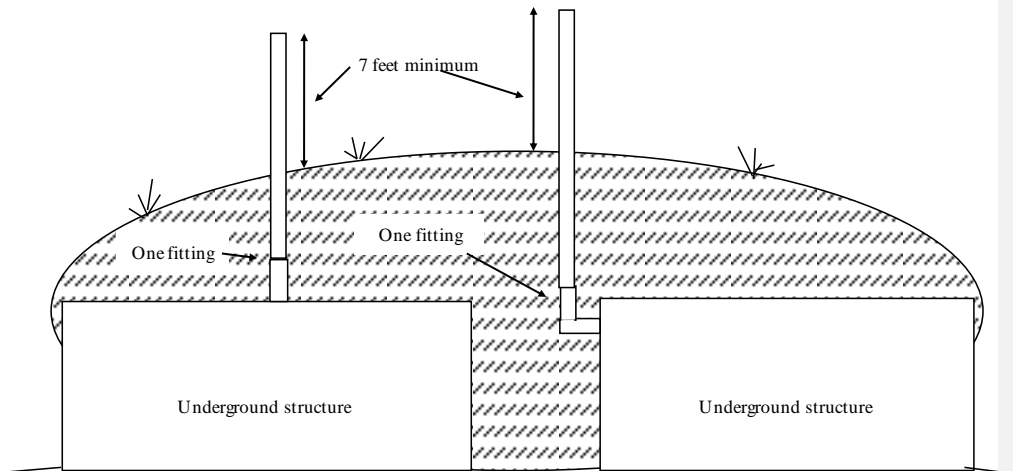

VENTS TERMINATING FOR UNDERGROUND STRUCTURES

**A-82.31 (17)(a) COMBINATION DRAIN AND VENT STACKS.**

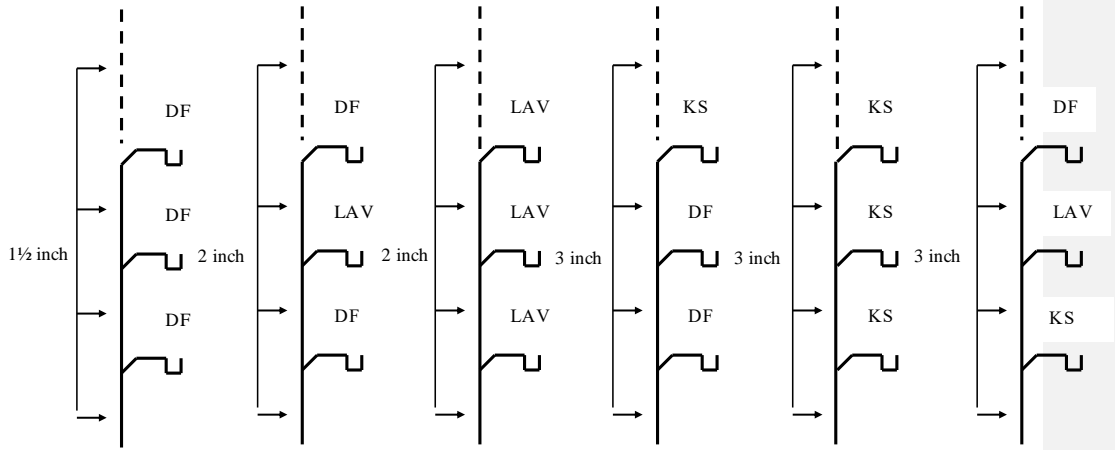

Most restrictive fixture determines stack size

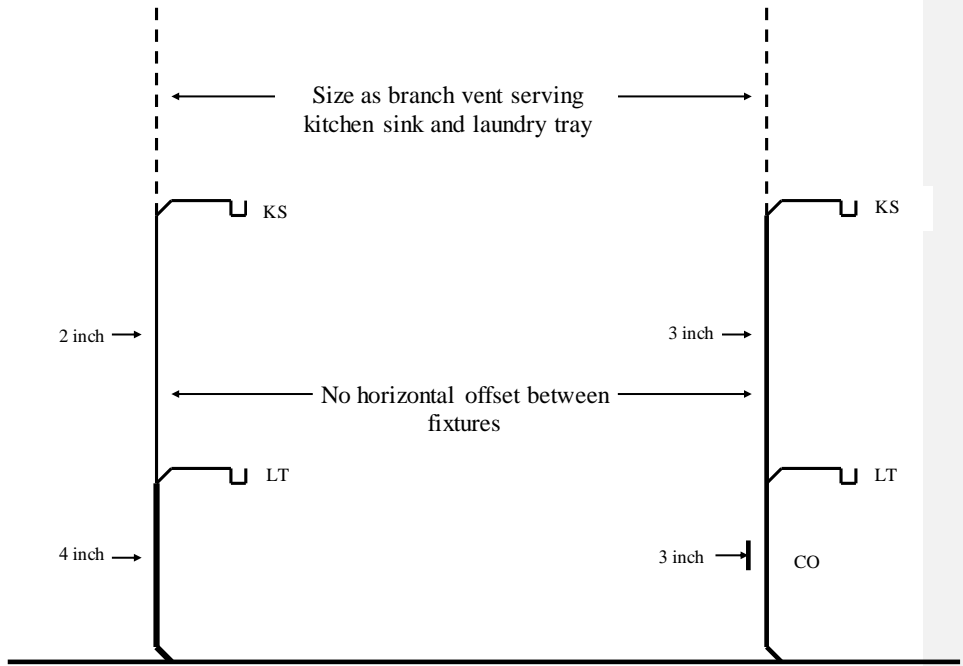

**A-82.31 (17) (b) COMBINATION DRAIN AND VENT BUILDING DRAIN.**

Stacks must be  $\frac{1}{2}$  size of building drain, but not less than 2 inches in diameter

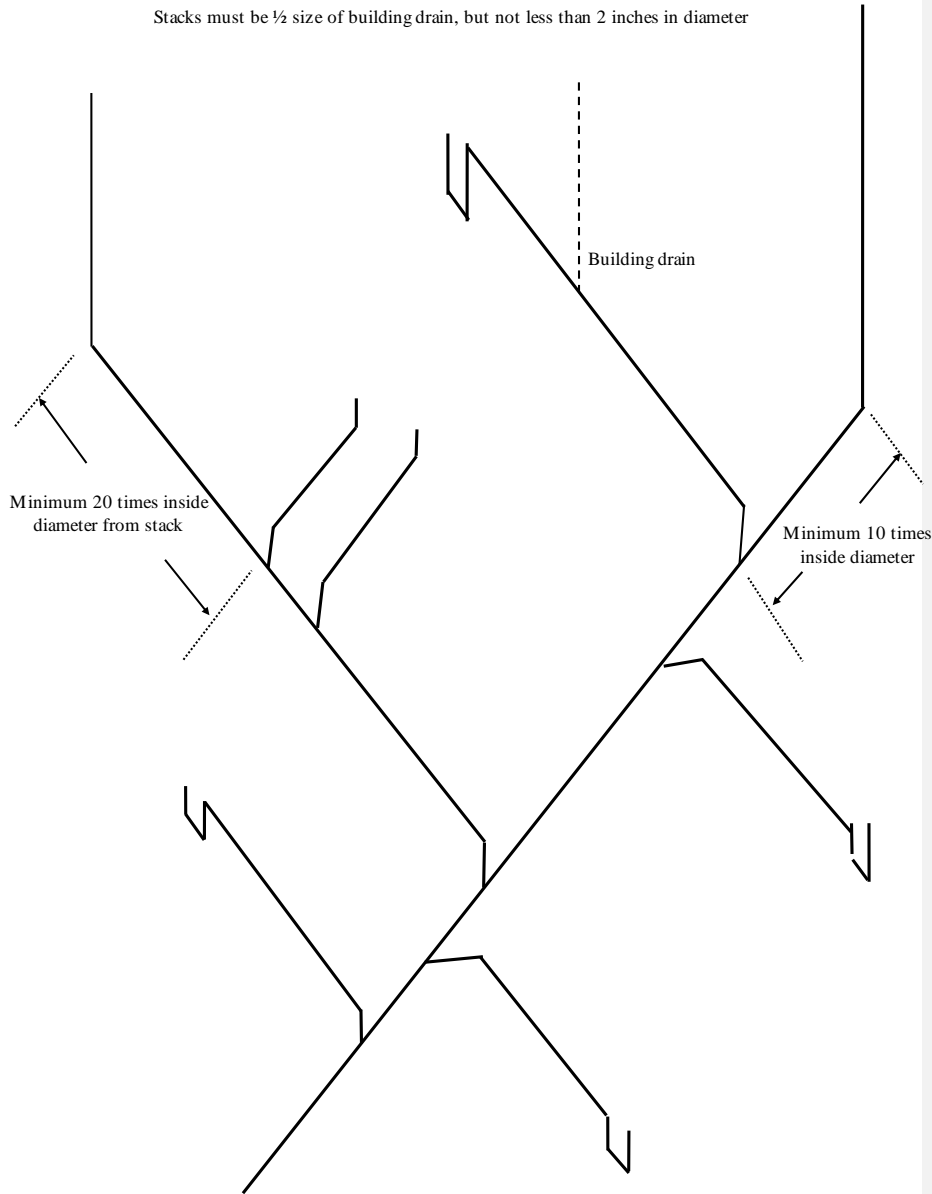



A-82.31 (17)(c) COMBINATION DRAIN AND VENT LABORATORY SINK VENTING.

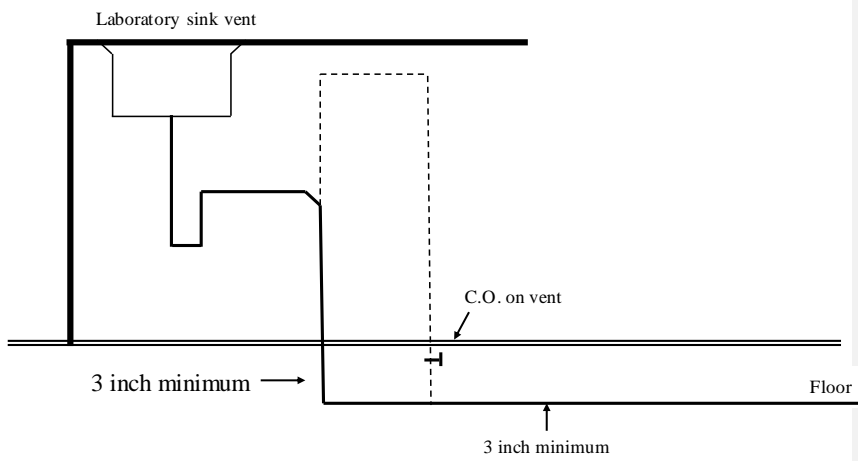
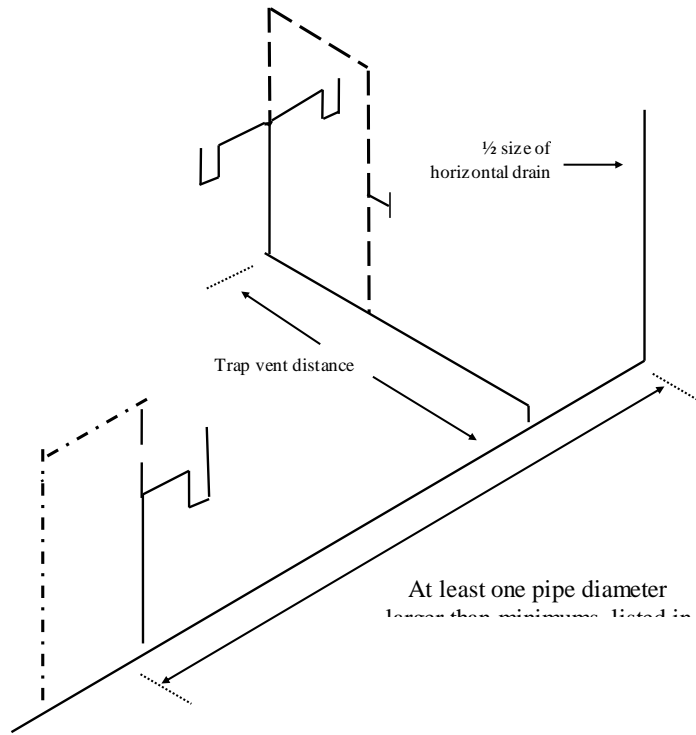

**A-82.32 (4) (b) INSTALLATION OF TRAPS.**

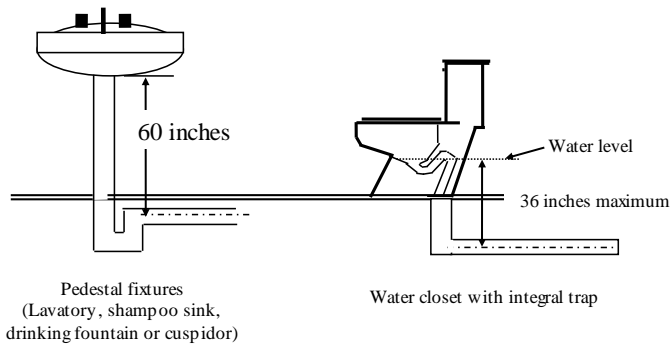
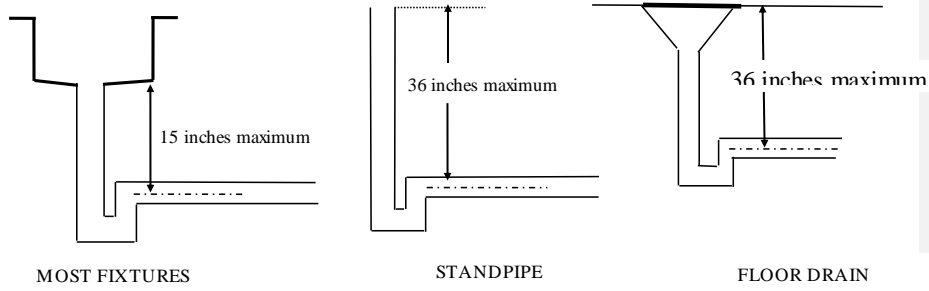

**VERTICAL DISTANCE BETWEEN FIXTURE DRAIN OUTLET AND TRAP**

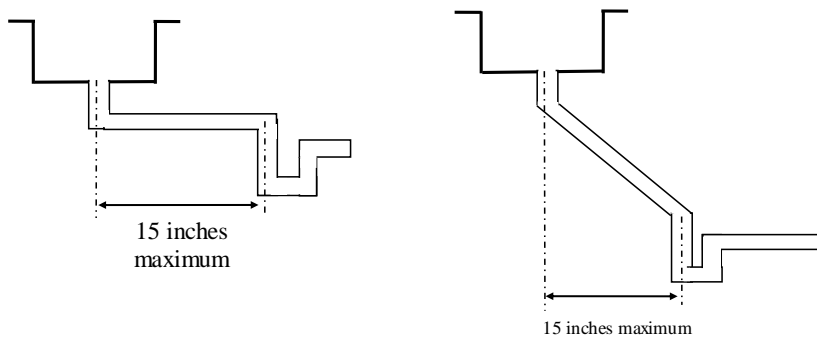

**HORIZONTAL DISTANCE BETWEEN FIXTURE DRAIN OUTLET AND TRAP**

**A-82.33 (6)-1. INDIRECT WASTEPIPING**

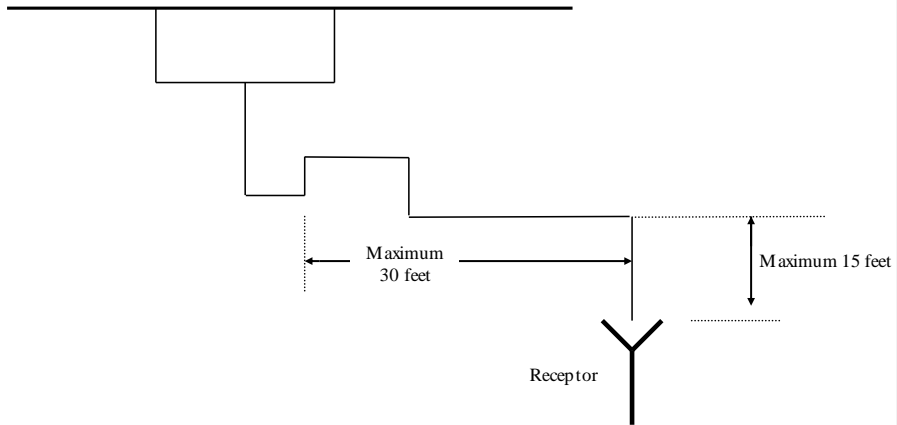

**A-82.33 (6)-2. LOCAL WASTEPIPING**

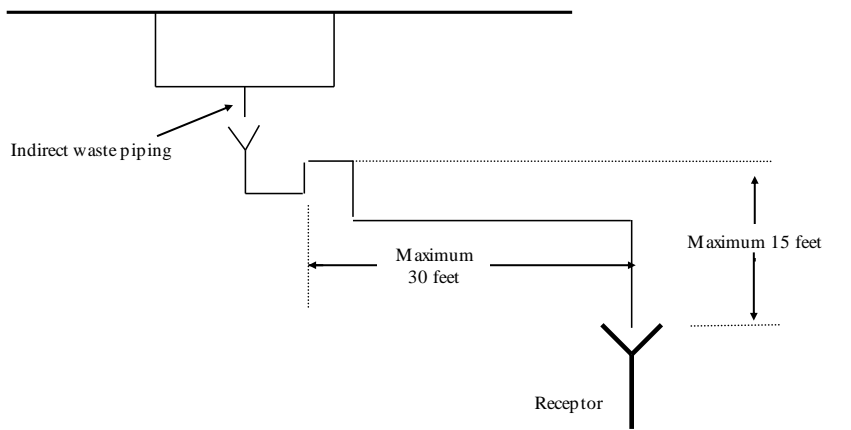

MAXIMUM LENGTH OF LOCAL WASTE PIPE

A-82.33 (7) AIR-GAPS AND AIR-BREAKS.

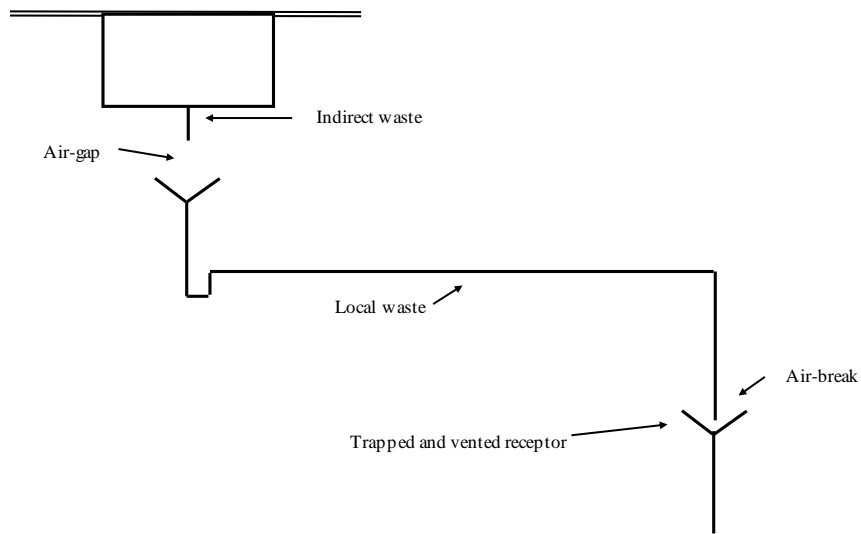
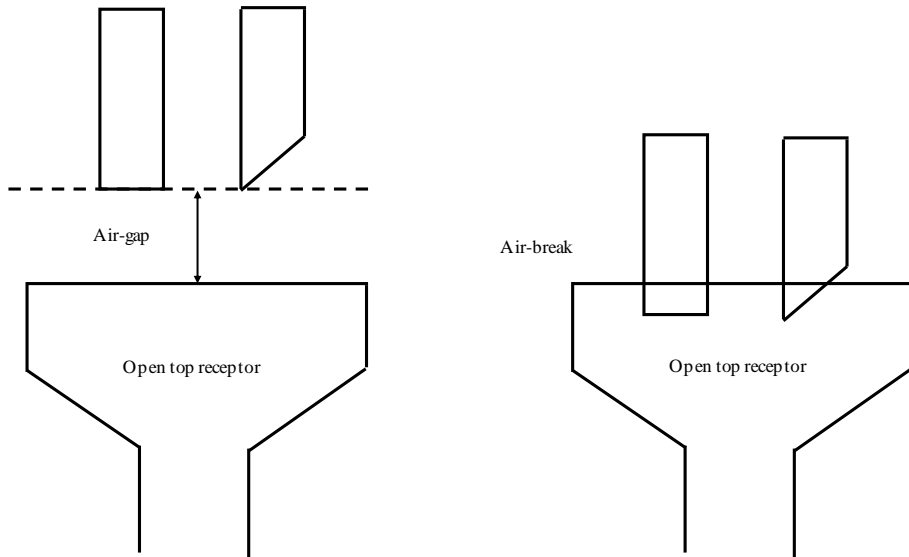

**A-82.33 (8) (a) WASTESINKS AND STANDPIPES.**

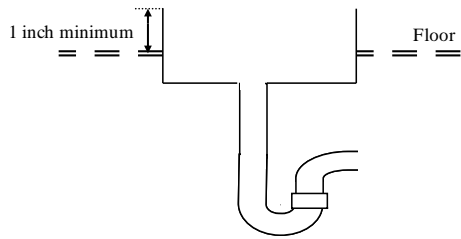

WASTE SINK IN FLOOR

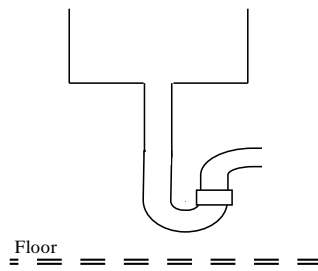

WASTE SINK ABOVE FLOOR

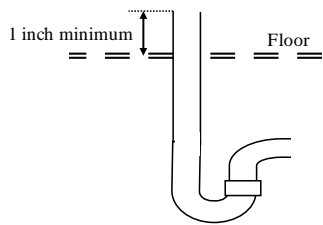

STANDPIPE IN FLOOR

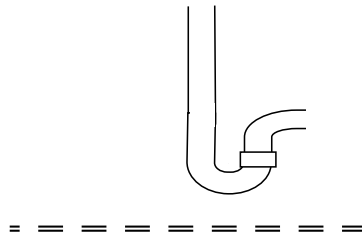

STANDPIPE ABOVE FLOOR

**A-82.33 (8) (b) FLOOR SINKS.**

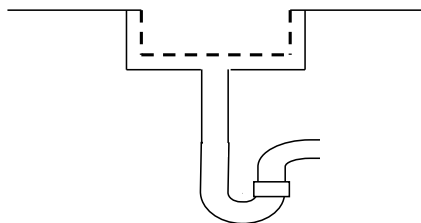

FLOOR SINK WITH BASKET

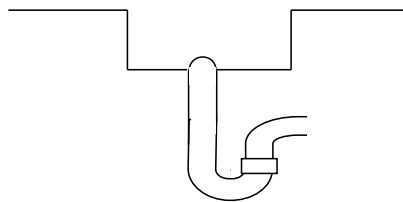

FLOOR SINK WITH DOME STRAINER



A-82.33 (8) (b) FLOOR SINK WITH GRATE OPENING.

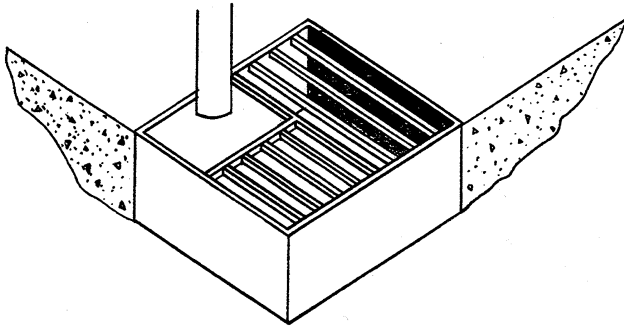

A-82.33 (8) (c)-1. LOCAL WASTE PIPING.

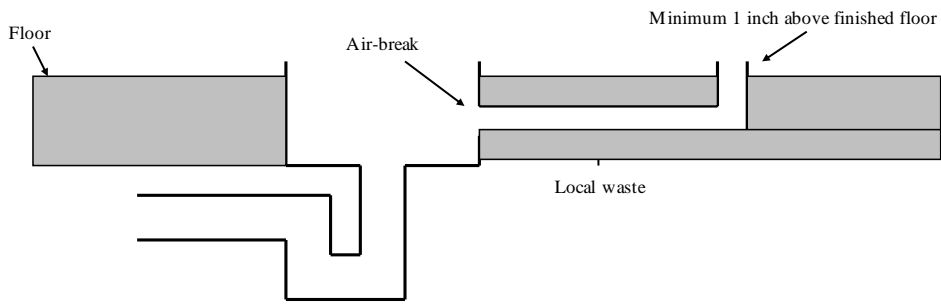

LOCAL WASTE LEADING TO A WASTE SINK, FLOOR SINK OR FLOOR DRAIN

**A-82.33 (8) (c)-2. LOCAL WASTE PIPING**

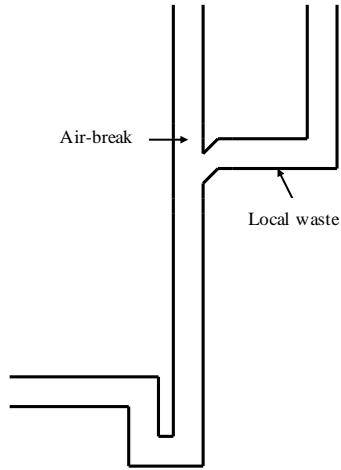

LOCAL WASTE DISCHARGING TO STANDPIPE

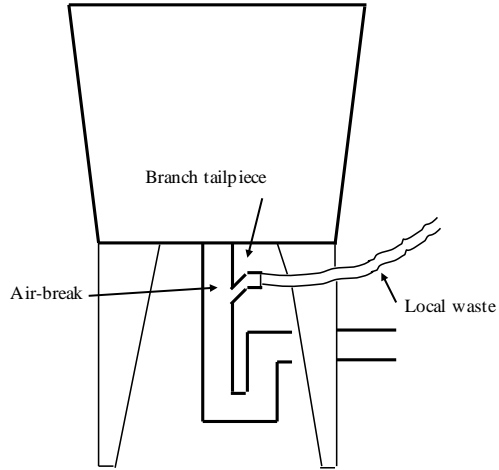

LOCAL WASTE DISCHARGING TO BRANCH TAILPIECE

**A-82.33 (8) (d)-1. LOCAL WASTE PIPING SERVING WATER HEATER TEMPERATURE AND PRESSURE RELIEF VALVES.**

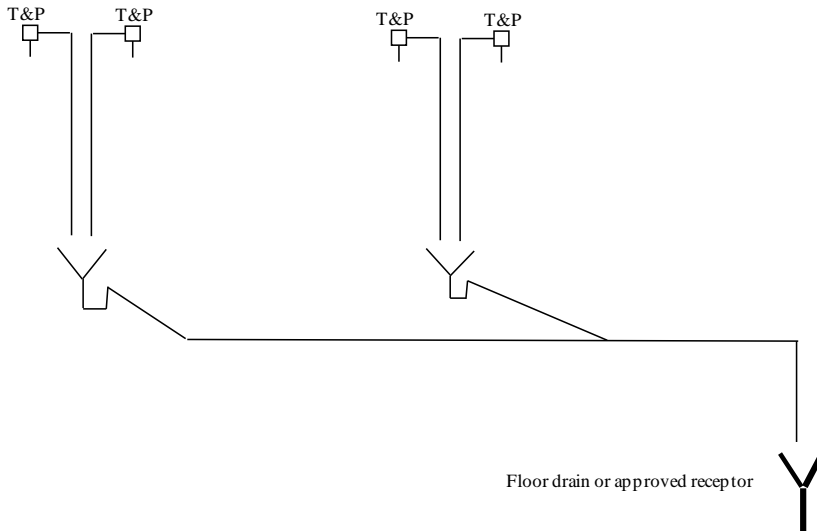



**A-82.33 (8) (d)-2. LOCAL WASTE PIPING SERVING WATER HEATER TEMPERATURE AND PRESSURE RELIEF VALVES.**

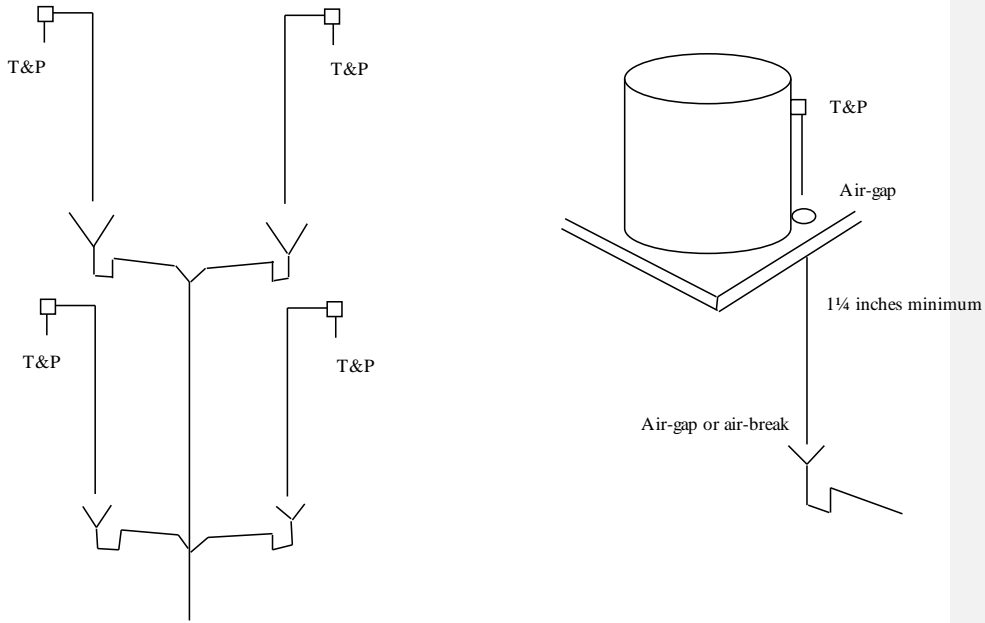

**A-82.33 (9) (c) COMMERCIAL GRAVITY DISCHARGE-TYPE CLOTHES WASHERS.**

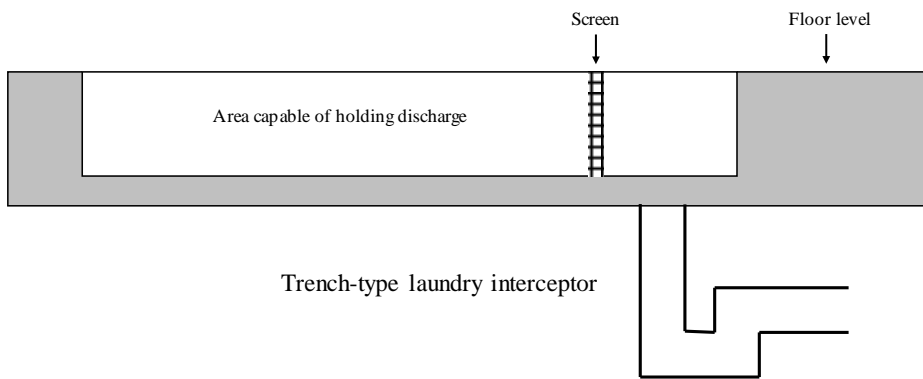

**A-82.33 (9) (d)-1. RESIDENTIAL-TYPE CLOTHES WASHERS.**

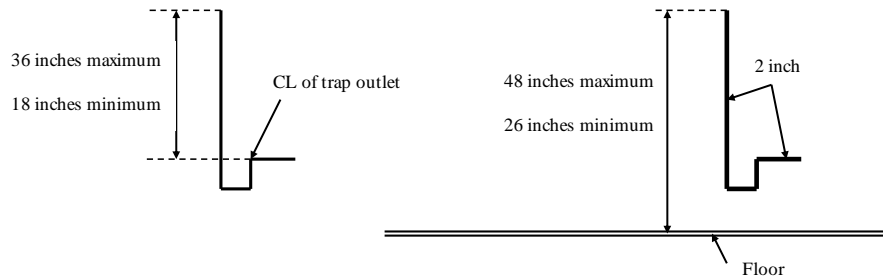

WASHER STANDPIPE RECEPTORS

**A-82.33 (9) (d)-2. RESIDENTIAL-TYPE DISHWASHERS.**

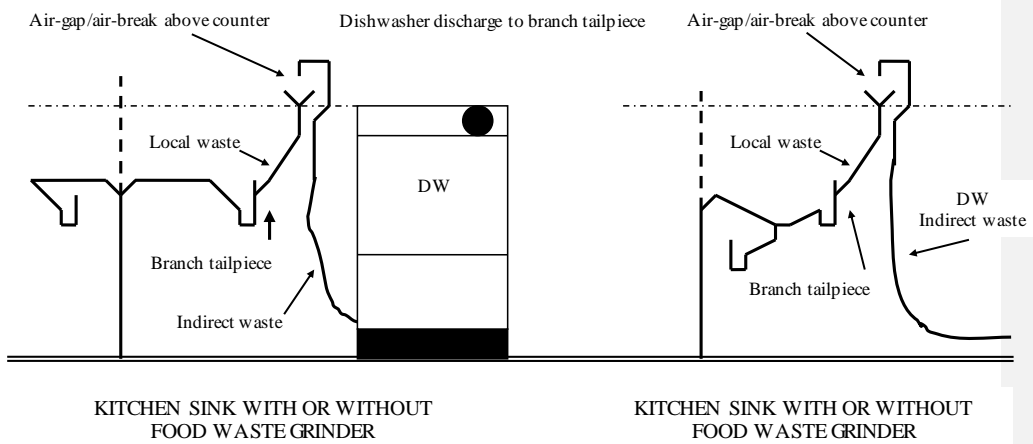

A-82.33 (9) (d)-3. RESIDENTIAL-TYPE DISHWASHERS

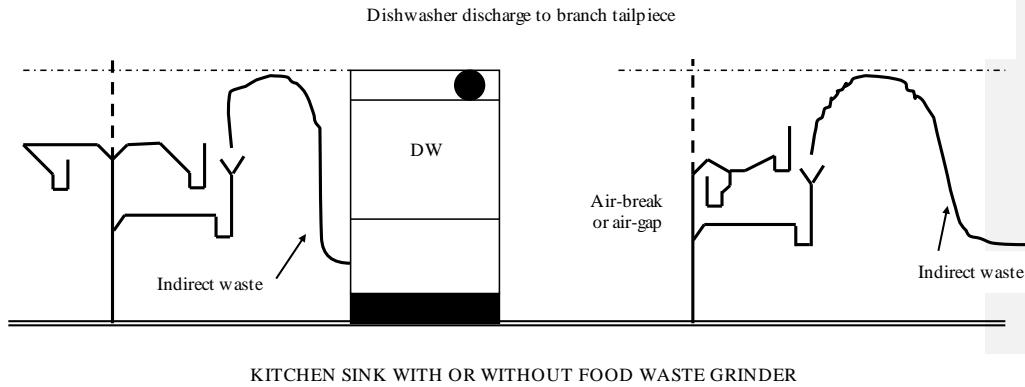

A-82.33 (9) (d)-4. COMMERCIAL DISHWASHERS.

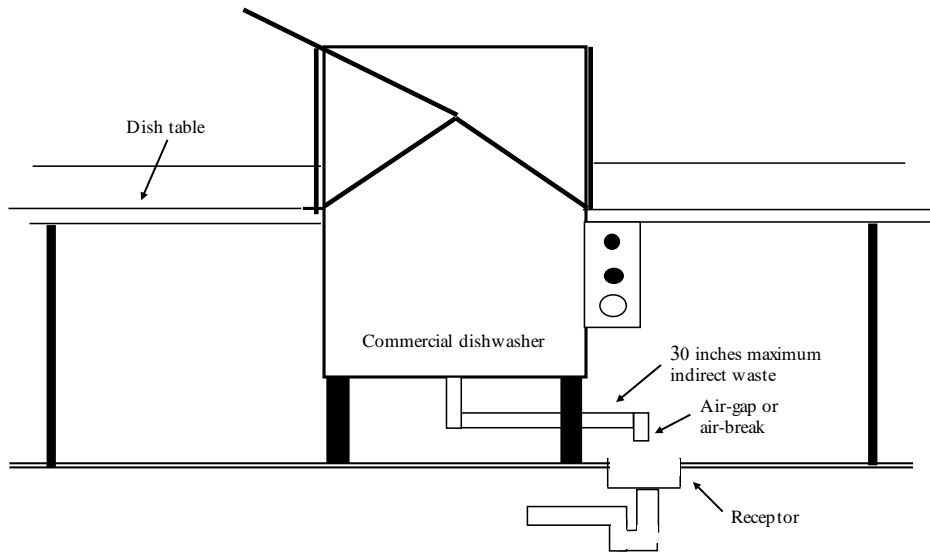

**A-82.33 (9) (f)-1. ELEVATOR PIT SUBSOIL AND FLOOR DRAINS.** Drains and sumps complying with ss. Comm 82.33 and 82.36 shall be provided.

**Note:** Section Comm 18.23 includes requirements for the installation of drains and sumps. Section Comm 18.23 reads: "Drains and sumps complying with ss. Comm 82.33 and 82.36 shall be provided. Drains connected directly to sanitary drain systems shall not be installed in elevator pits."

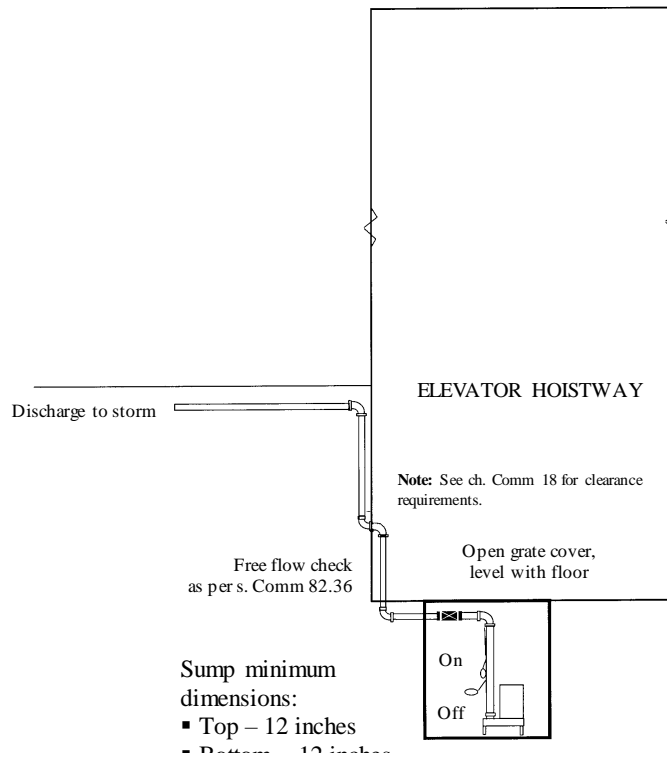

**A-82.33 (9) (f)-2. ELEVATOR PIT SUBSOIL AND FLOOR DRAINS.**

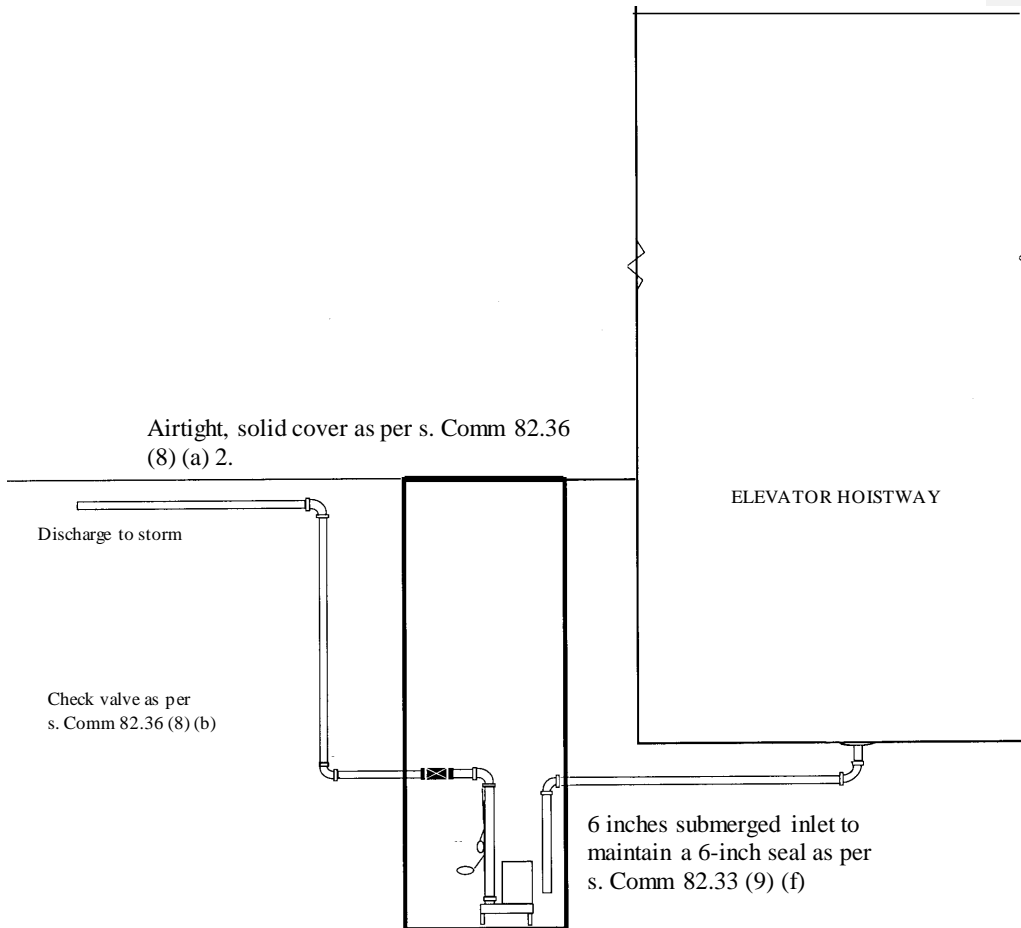

ELEVATOR DRAIN DISCHARGE – STORM DRAIN CONNECTION

**A-82.33 (9) (g) 1. BAR AND SODA FOUNTAIN SINKS.**

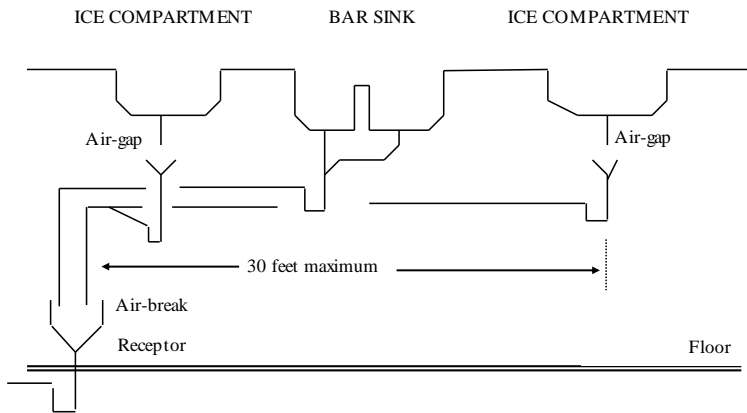

**A-82.33 (9) (g) 2. BEER TAPS, COFFEE MAKERS, GLASS FILLERS AND SODA DISPENSERS.**

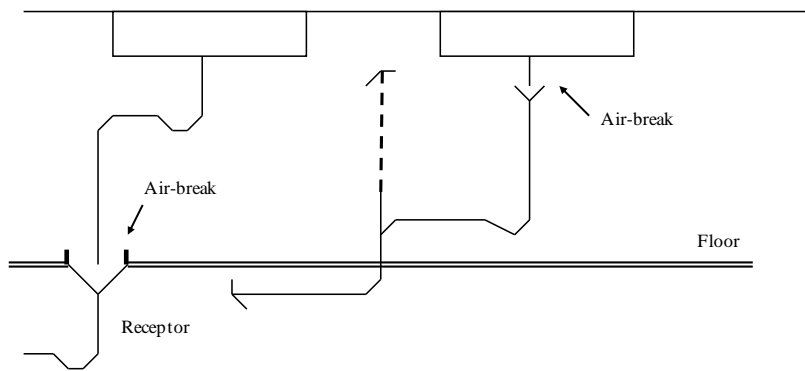

**A-82.33 (9) (g) 3. NOVELTY BOXES AND ICE COMPARTMENTS AND ICE CREAM DIPPER WELLS.**

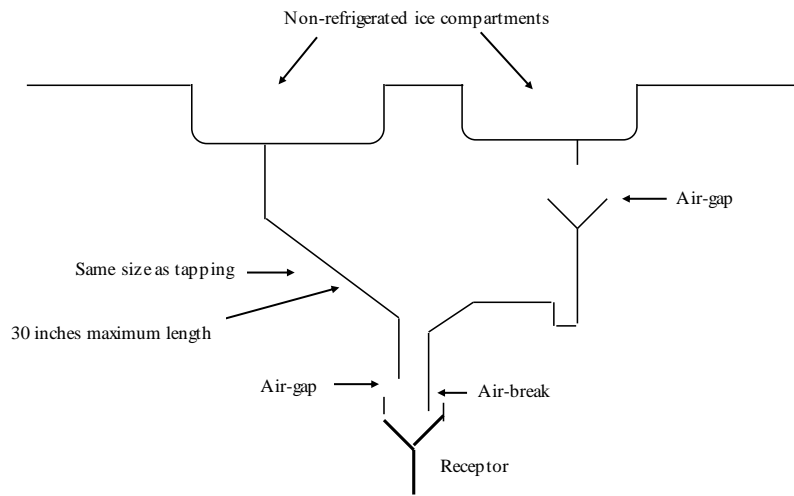
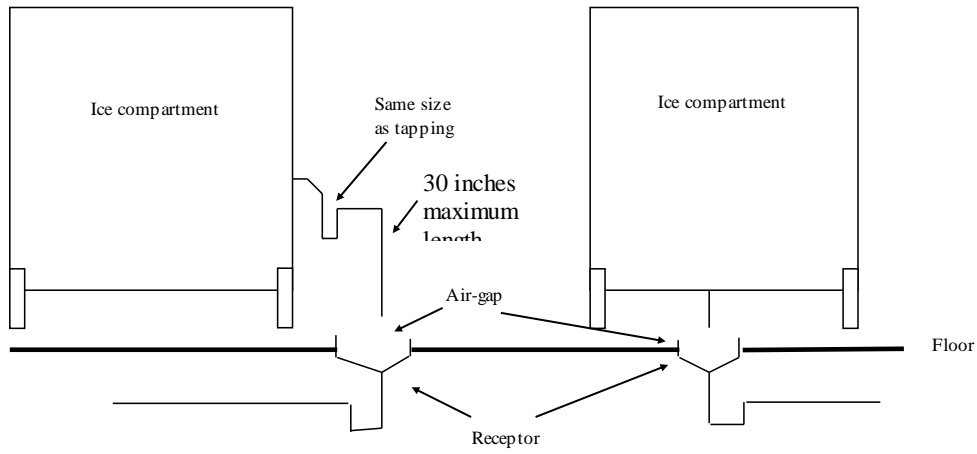

A-82.33 (9) (g) 4. REFRIGERATED FOOD STORAGE ROOMS, COMPARTMENTS AND DISPLAY CASES.

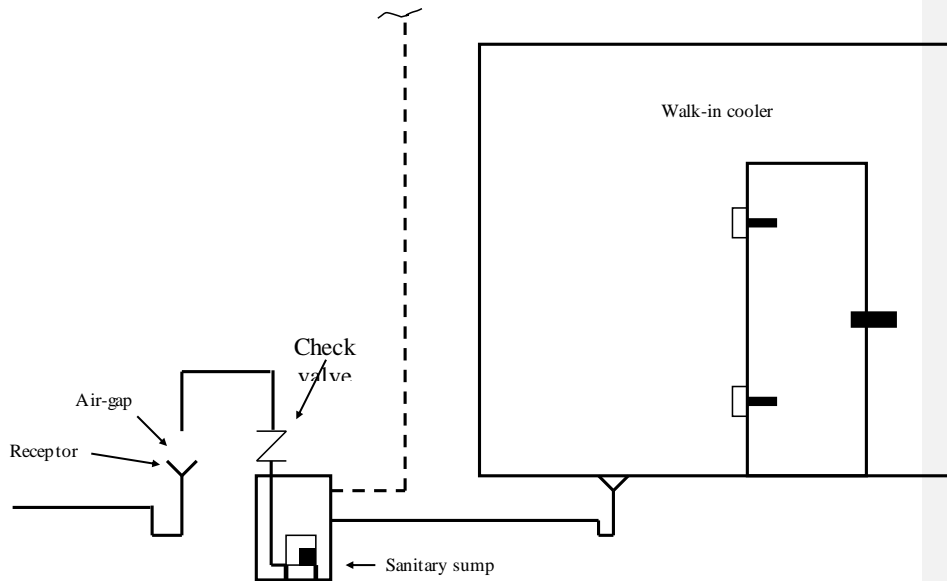
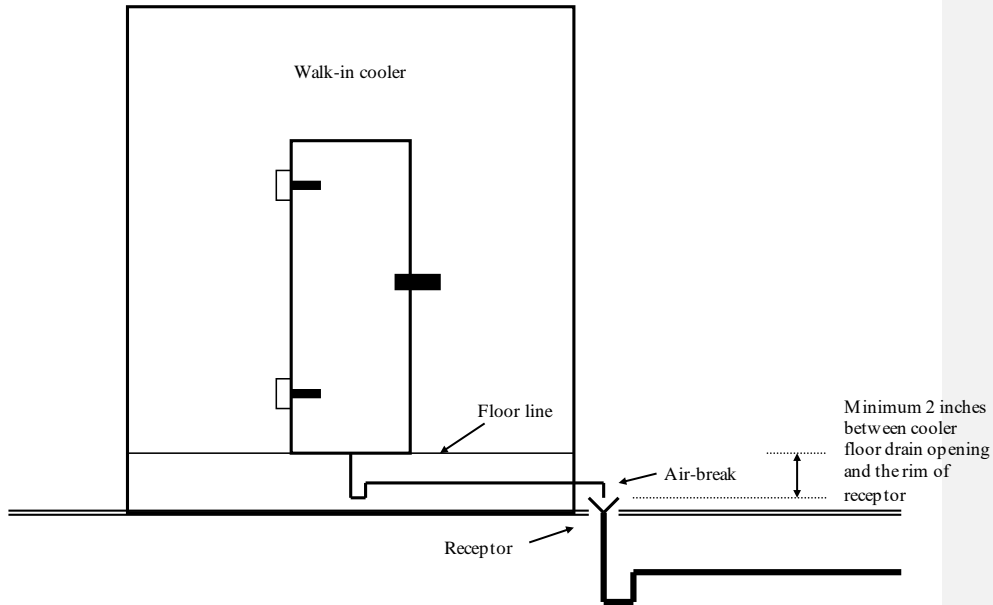



A-82.33 (9) (g) 5. MISCELLANEOUS FOOD HANDLING EQUIPMENT.

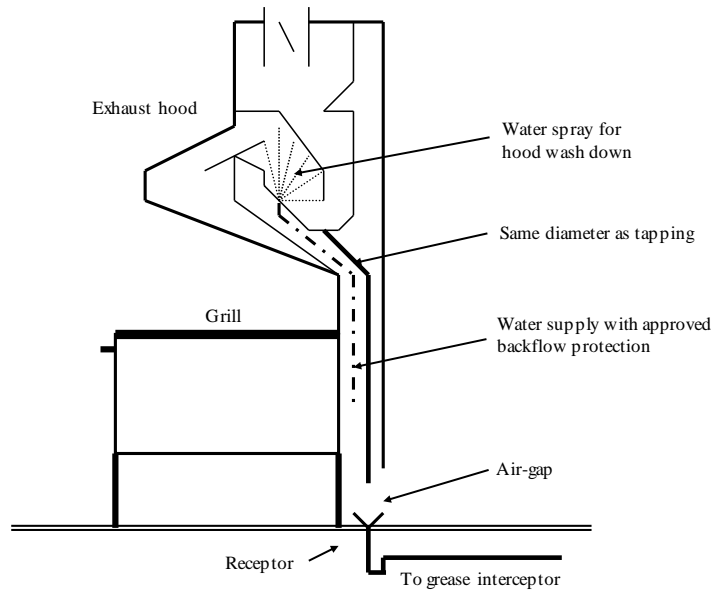

A-82.33 (9) (g) 5. MISCELLANEOUS FOOD HANDLING EQUIPMENT.

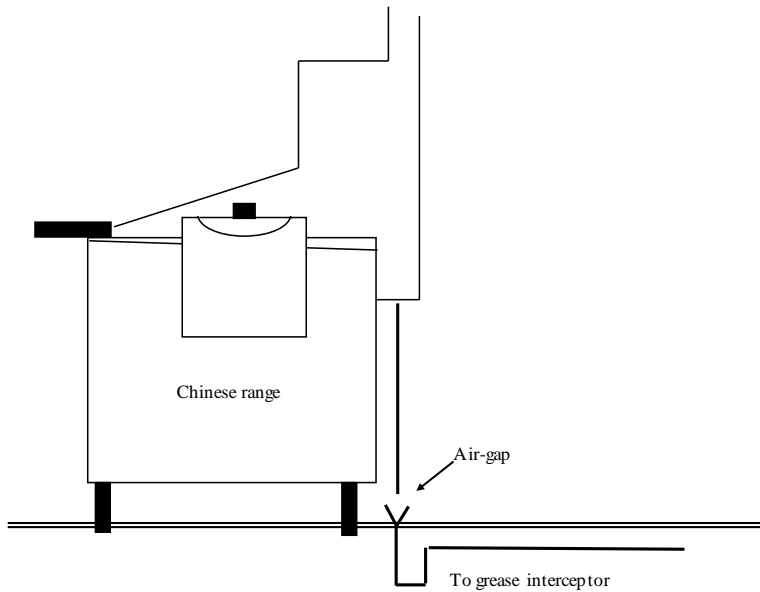

**A-82.34 (4)-1. GARAGE CATCH BASINS.**

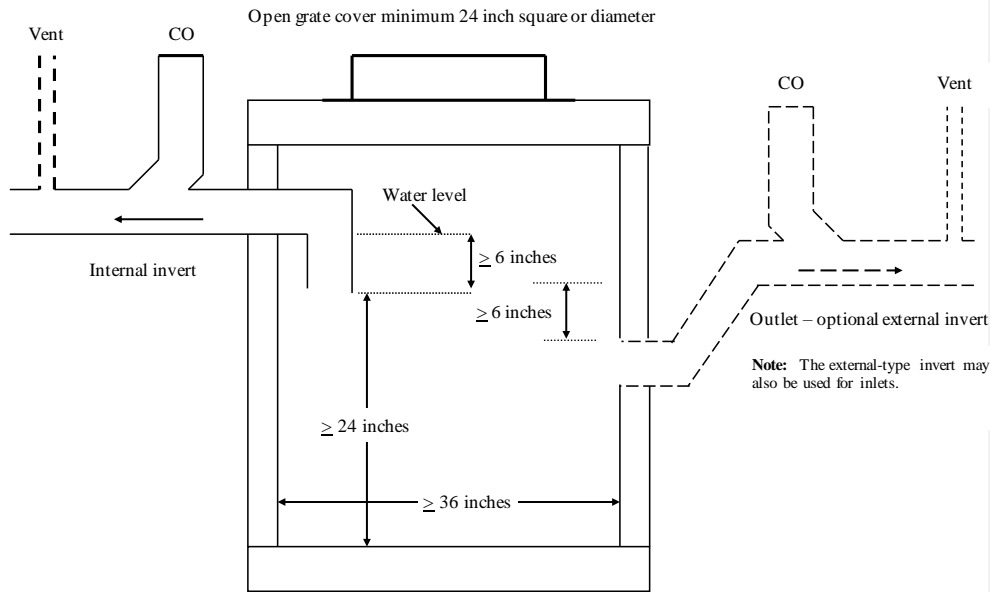

**A-82.34 (4)-2. TRAPPED FIXTURES DISCHARGING TO CATCH BASIN.**

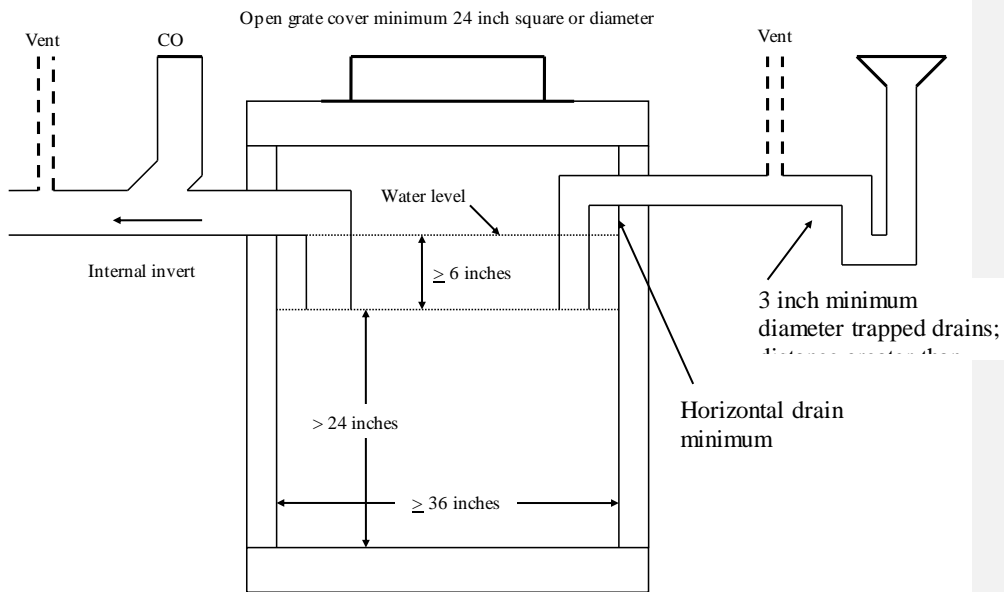

**A-82.34 (4)-3. TRAPPED FIXTURE DISCHARGING INTO GARAGE CATCH BASIN.**

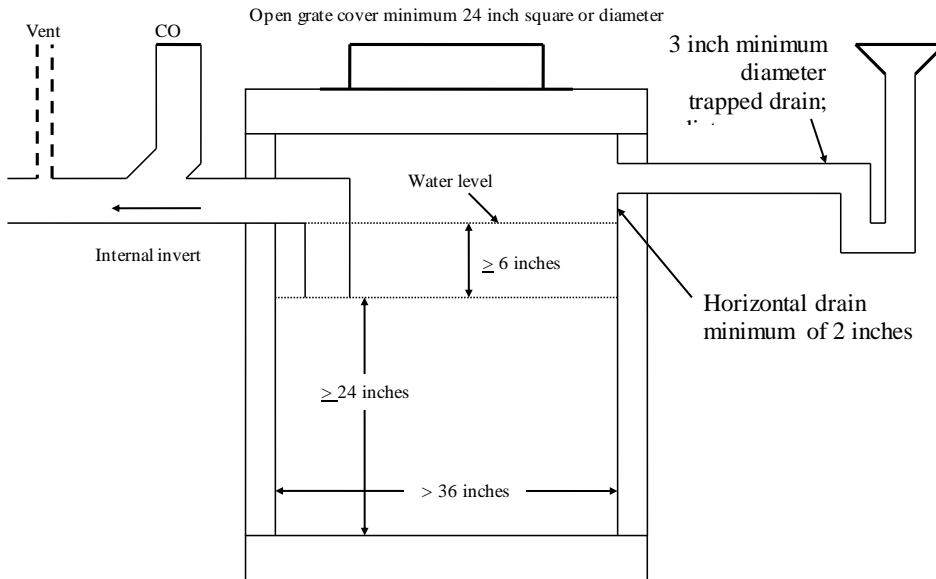

**A-82.34 (4)-4. FIXTURES WITHOUT TRAPS DISCHARGING TO CATCH BASIN.**

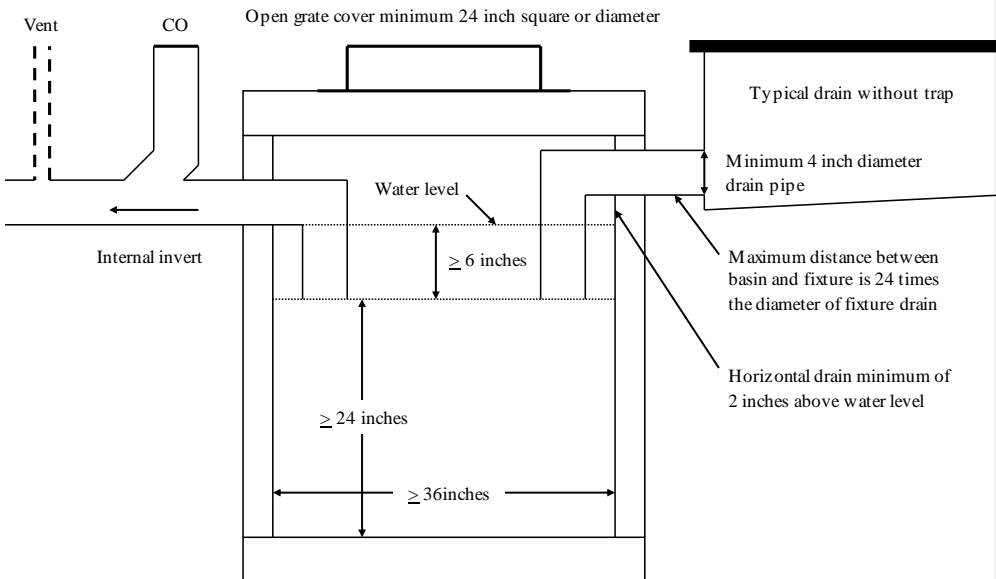

**A-82.34 (4)-5. GARAGE CATCH BASIN WITH FIXTURES ON SEPARATE FLOOR LEVELS.**

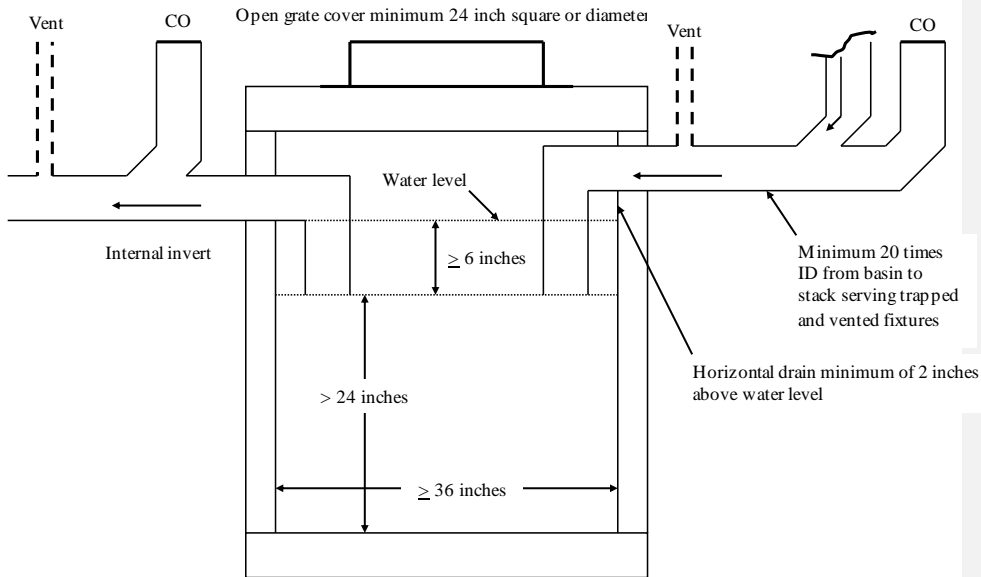

**A-82.34 (4)-6. GARAGE CATCH BASIN RECEIVING PRESSURIZED DRAINS.**

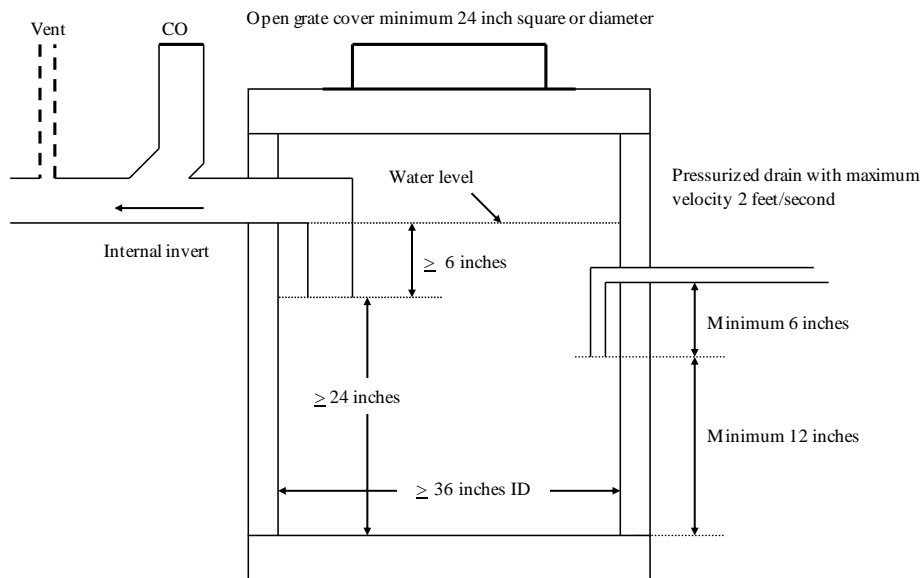

A-82.34 (5) (b)-1. EXTERIOR GREASE INTERCEPTORS.

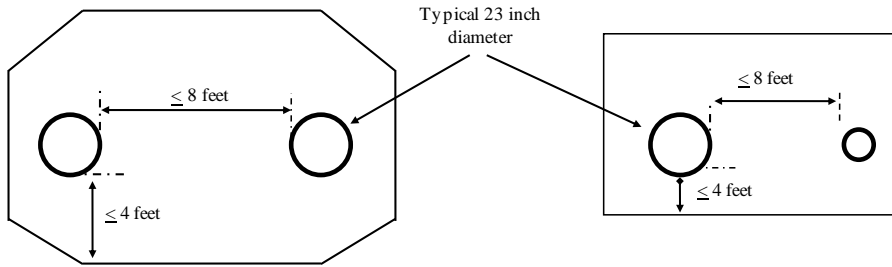

GREASE INTERCEPTOR MANHOLE LOCATION

A-82.34 (5) (b)-2. EXTERIOR GREASE INTERCEPTORS.

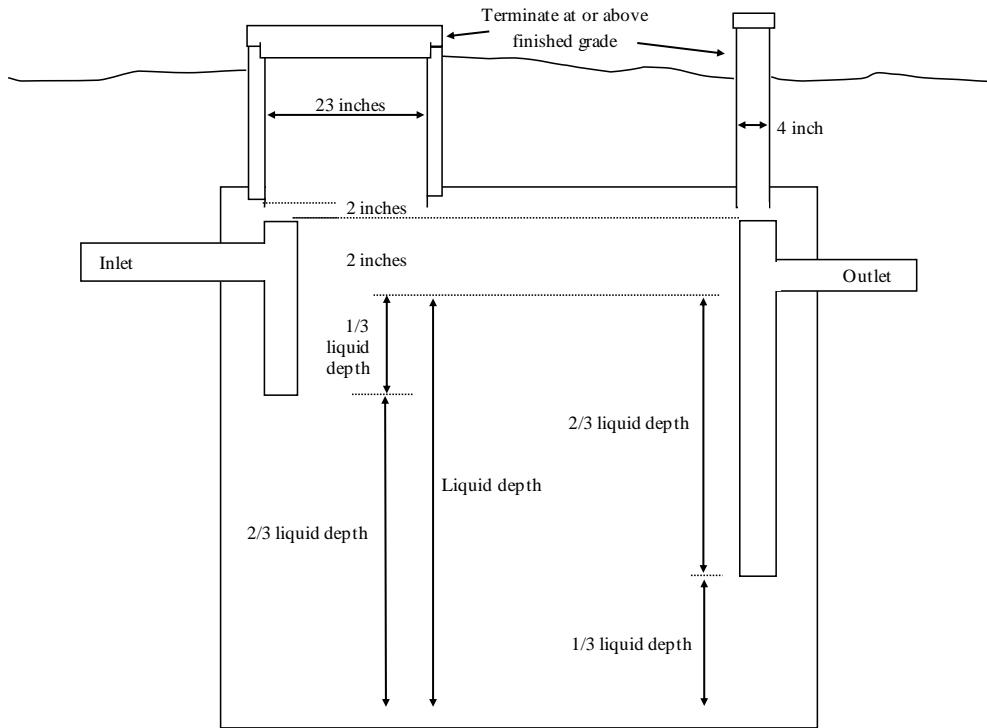

A-82.34 (5) (c) INTERIOR GREASE INTERCEPTORS.

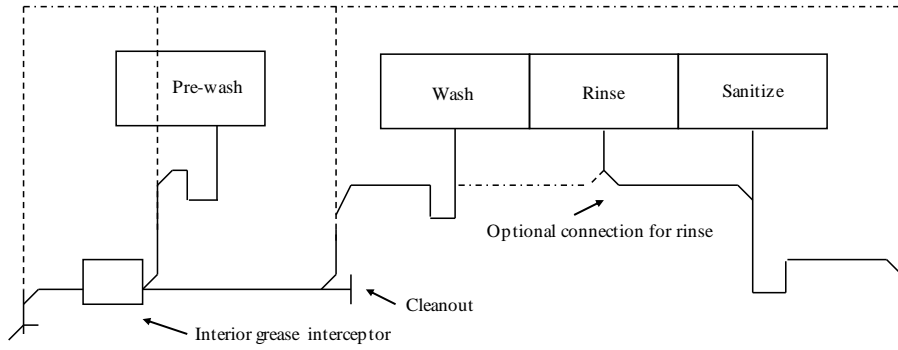

PRE-WASH AND 3-COMPARTMENT SCULLERY SINK

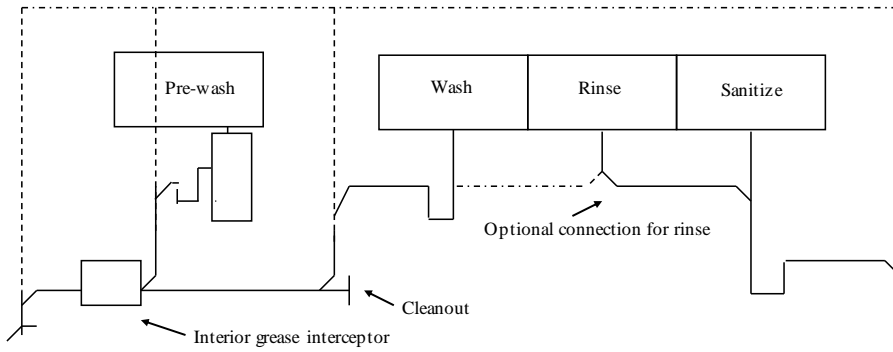

PRE-WASH WITH DISPOSAL AND 3-COMPARTMENT SCULLERY SINK

A-82.34 (6) AUTOMATIC CAR WASHES.

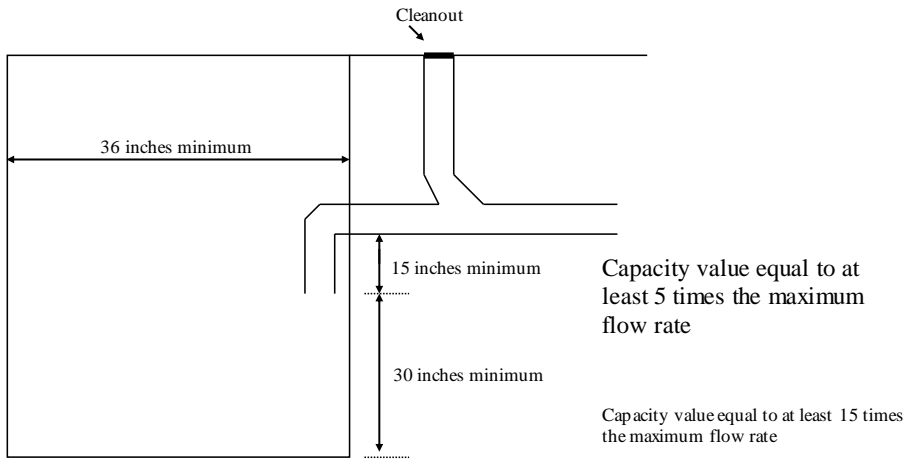

CAR WASH INTERIOR WITH INVERT INSIDE OF BASIN

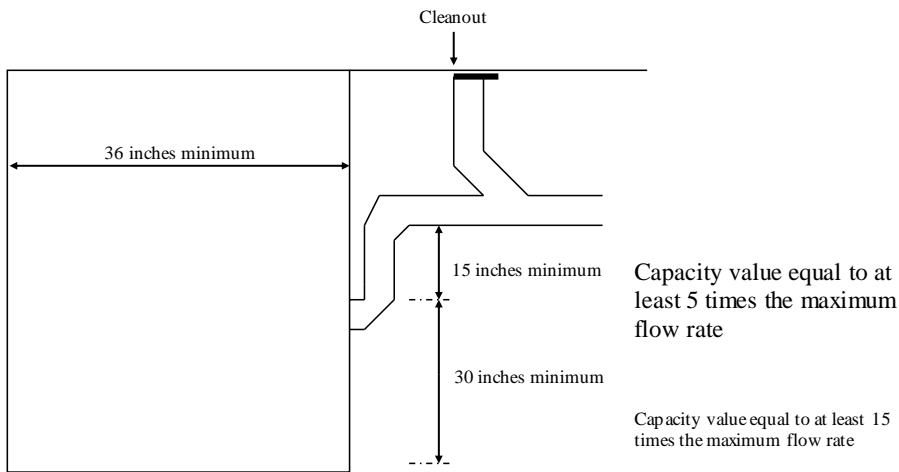

CAR WASH INTERIOR WITH INVERT OUTSIDE OF BASIN

A-82.34 (7) COMMERCIAL LAUNDRIES. See also A-82.33 (9)-4. for trench type interceptors.

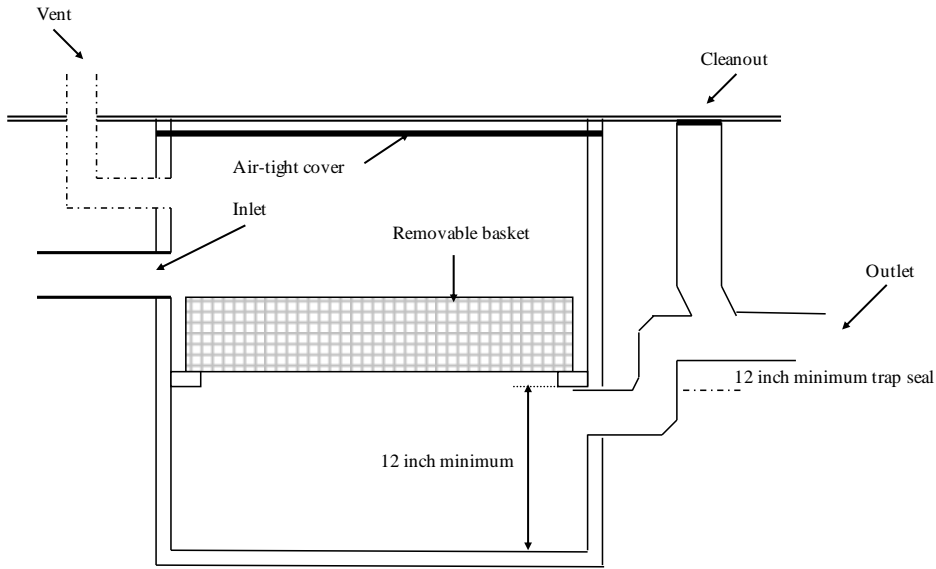

IN LINE LAUNDRY INTERCEPTOR

A-82.34 (8) OIL AND FLAMMABLE LIQUIDS INTERCEPTOR. Vents as shown must terminate independently.

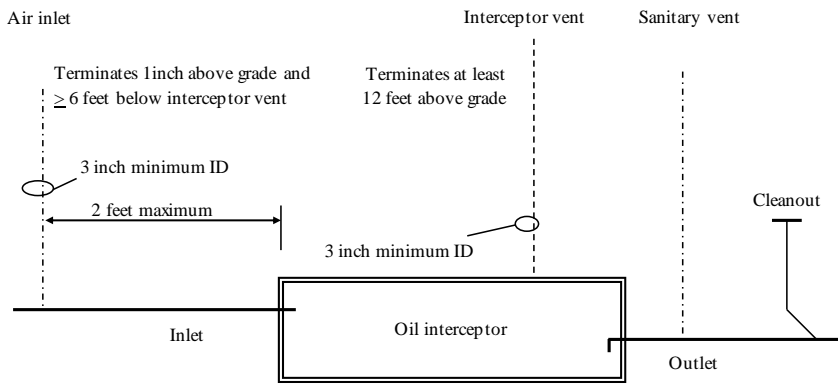



**A-82.34 (13) PLASTER AND HEAVY SOLIDS TRAP TYPE INTERCEPTORS.**

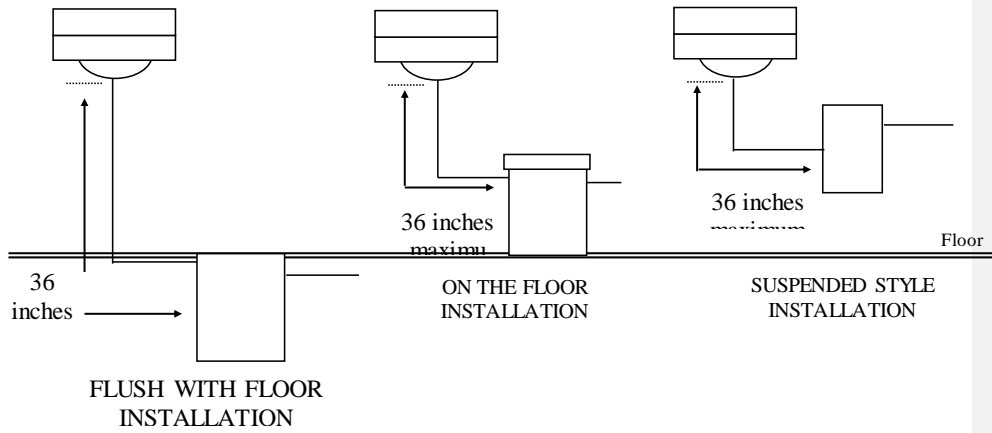

**A-82.34 (14) CHEMICAL DILUTION AND NEUTRALIZING BASINS.**

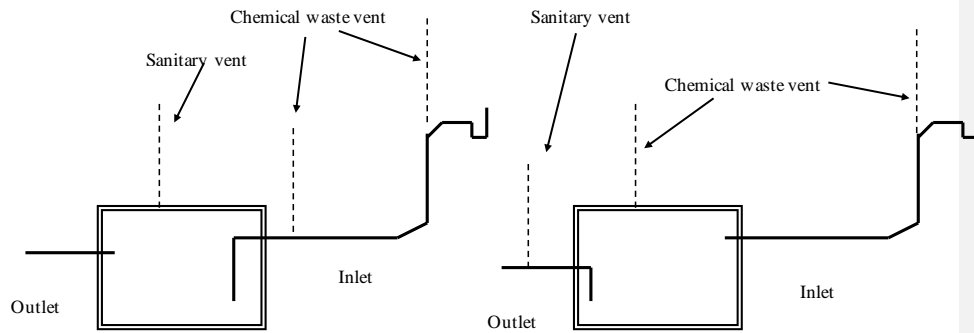

**A-82.35 (3) CLEANOUTS SERVING HORIZONTAL DRAINS WITHIN OR UNDER A BUILDING.**

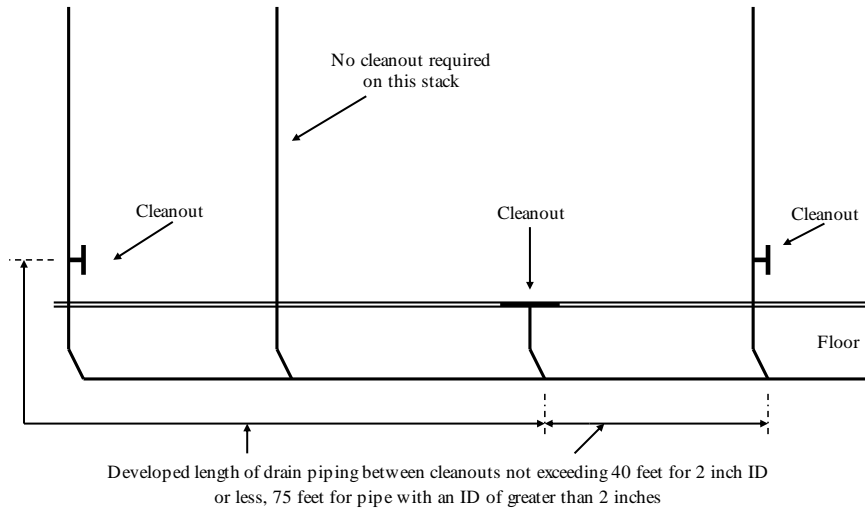

A-82.35 (5) (a) CLEANOUT EXTENSION TO GRADE.

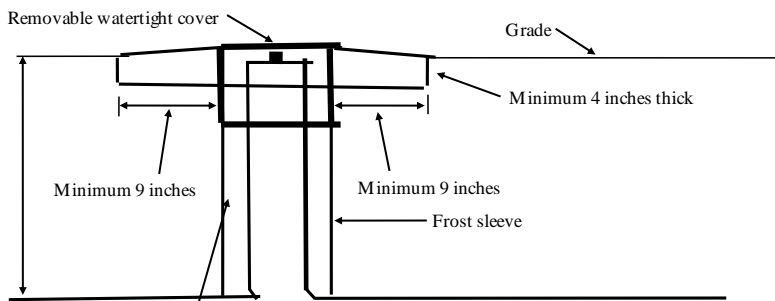
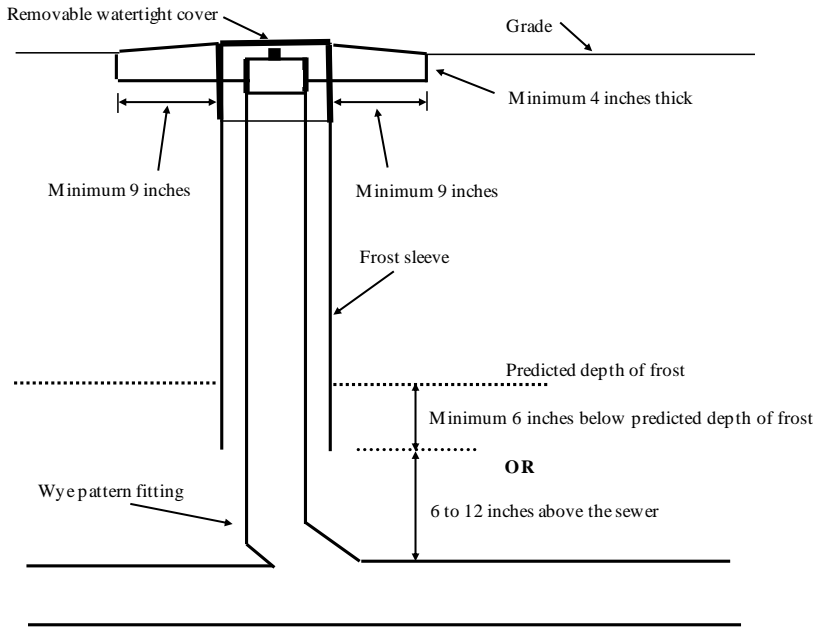

If depth is 18 inches or less, this may be a sanitary pattern fitting

**A-82.35 (8) OUTSIDE DROP INTO AN EXISTING MANHOLE.**

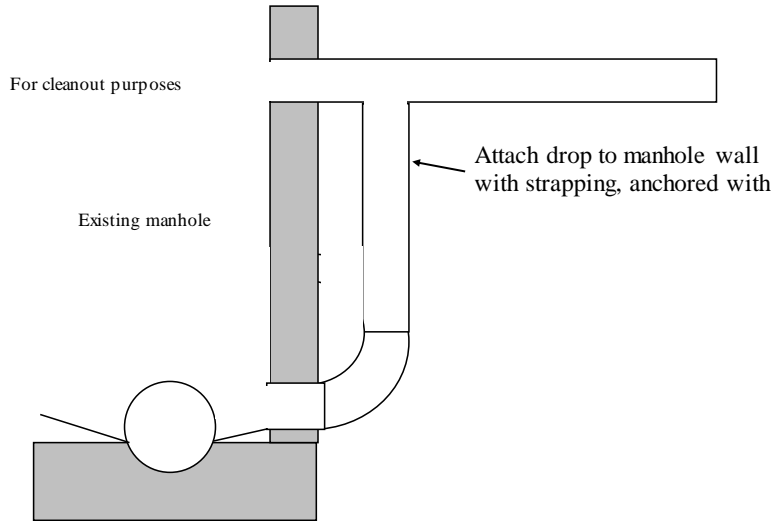

A-82.36(3) SOURCES OF POLLUTANTS IN WISCONSIN STORMWATER.

**SOURCES OF POLLUTANTS IN WISCONSIN STORMWATER**

Geometric Mean Concentrations of Contaminants in Runoff from Source-Area and Storm-Sewer Outfalls

Contaminant	Feeder Streets	Collector Streets	Arterial Streets	Lawns	Drive-ways	Roofs	Parking Lots	Outfall
Residential Source Areas								
Total Solids (mg/L)	796	493	-	600	306	91	-	369
Suspended Solids (mg/L)	662	326	-	397	173	27	-	262
Total Phosphorus (mg/L)	1.31	1/07	-	2.67	1.16	.15	-	.66
Total Recoverable Copper (µg/L)	24	56	-	13	17	15	-	16
Total Recoverable Lead (µg/L)	33	55	-	--	17	21	-	32
Total Recoverable Zinc (µg/L)	220	339	-	59	107	149	-	203
Fecal Coliform (cfu/100mL)	92,061	56,554	-	42,093	34,294	294	0	175,106
Commercial Source Areas								
Total Solids (mg/L)	-	---	373	-	-	112	127	---
Suspended Solids (mg/L)	-	---	232	-	-	15	58	---
Total Phosphorus (mg/L)	-	---	.47	-	-	.20	.19	---
Total Recoverable Copper (µg/L)	-	---	46	-	-	9	15	---
Total Recoverable Lead (µg/L)	-	---	50	-	-	9	22	---
Total Recoverable Zinc (µg/L)	-	---	508	-	-	330	178	---
Fecal Coliform (cfu/100mL)	-	---	9,627	-	-	1,117	1,758	---
Industrial Source Areas								
Total Solids (mg/L)	-	958	879	---	-	78	531	267
Suspended Solids (mg/L)	-	763	690	---	-	41	312	146
Total Phosphorus (mg/L)	-	1.5	.94	---	-	.11	.39	.34
Total Recoverable Copper (µg/L)	-	76	74	---	-	6	41	28
Total Recoverable Lead (µg/L)	-	86	60	---	-	8	38	25
Total Recoverable Zinc (µg/L)	-	479	575	---	-	1,155	304	265
Fecal Coliform (cfu/100mL)	-	8,338	4,587	---	-	144	2,705	5,114

Source: Bannerman, R.T.; Owens D.W.; Dodds, R.B.; and Homewer, N.J., 1993, Sources of Pollutants in Wisconsin Stormwater: Water Science Technology, v.28, nos. 3-5, pp. 241-259.

**Note:** Single dash indicates source area is not in the land use; double dash indicates insufficient data; and triple dash indicates values are shared with those above for the same source area. The relatively large concentrations of zinc in roof runoff indicate that galvanized roofing materials were a source of the zinc. One-third of the residential roofs had galvanized downspouts. Roofing materials also might be a source of copper and lead in the runoff from residential roofs. Concentrations of dissolved copper and total recoverable copper and lead were slightly larger in the residential roof runoff than in runoff from driveways and lawns.

**Note:** The department has accepted that a "visible sheen" is defined as 15 mg/L grease and oil.

**A-82.36 (3)-1. BEST MANAGEMENT PRACTICES (BMPs).** A description of the proposed best management practices to be used for stormwater management in the protection of water quality include, but are not limited to, the following:

- a. Detention, retention and sedimentation facilities, including plans for discharges from the facilities, maintenance plans and predictions of water quality.
- b. Areas of the site to be used or reserved for infiltration including a prediction of the impact on groundwater quality.
- c. Any other relevant volume controls or measures.
- d. Any other relevant source control practices not described.
- e. Any treatment device, including plans for discharges from the facilities, maintenance plans and predictions of water quality.

**Note:** Section NR 151.002 (4) reads: “‘Best management practices’ or ‘BMPs’ means structural or non-structural measures, practices, techniques or devices employed to avoid or minimize soil, sediment or pollutants carried in runoff to waters of the state.”

**A-82.36 (4)-1. RATIONAL METHOD.** The equation procedure for using the rational method formula is as follows:

$$Q = Aci \text{ (in cubic feet per second)}$$

Where: Q = Runoff (in cubic feet per second)  
A = Drainage area (in acres)  
c = Coefficient of runoff (a dimensionless number)  
i = Intensity of rainfall (in inches per hour)

$$Q = \frac{(0.0104)ciA}{1.96} \text{ (in gallons per minute)}$$

Where: Q = Runoff (in gallons per minute)  
c = Coefficient of runoff (a dimensionless number)  
i = Intensity of rainfall (in inches per hour)  
A = Drainage area (in square feet)

A-82.36 (4)-2. RUNOFF COEFFICIENTS. Tables Detail A and B are for using the rational formula.

**DETAIL A: RUNOFF COEFFICIENTS (C), RATIONAL FORMULA**

Land Use	Percent Impervious Area	Design Storm 24-Hour Event	Hydrologic Soil Group											
			A			B			C			D		
			Slope Range (%)			Slope Range (%)			Slope Range (%)			Slope Range (%)		
			0-2	2-6	> 6	0-2	2-6	> 6	0-2	2-6	> 6	0-2	2-6	> 6
Industrial	90	2- and 10-year	0.67	0.58	0.68	0.68	0.68	0.69	0.68	0.69	0.69	0.69	0.69	0.70
		25-, 50-, and 100-year	0.85	0.85	0.86	0.85	0.86	0.86	0.86	0.86	0.86	0.87	0.86	0.86
Commercial	95	2- and 10-year	0.71	0.71	0.72	0.71	0.72	0.72	0.72	0.72	0.72	0.72	0.72	0.72
		25-, 50-, and 100-year	0.88	0.89	0.89	0.89	0.89	0.89	0.89	0.89	0.89	0.89	0.89	0.89
Residential: gh-density (>6 units/acre)	60	2- and 10-year	0.47	0.49	0.50	0.48	0.50	0.52	0.49	0.51	0.54	0.51	0.53	0.56
		25-, 50-, and 100-year	0.58	0.60	0.61	0.59	0.61	0.64	0.60	0.62	0.66	0.62	0.66	0.69
Medium-density (2-6 units/acre)	30	2- and 10-year	0.25	0.28	0.31	0.27	0.30	0.35	0.30	0.33	0.38	0.33	0.36	0.42
		25-, 50-, and 100-year	0.33	0.37	0.40	0.35	0.39	0.44	0.38	0.42	0.49	0.41	0.45	0.54
Low-density (0.7-2 units/acre)	15	2- and 10-year	0.14	0.19	0.22	0.17	0.21	0.26	0.20	0.25	0.31	0.24	0.28	0.35
		25-, 50-, and 100-year	0.22	0.26	0.29	0.24	0.28	0.34	0.28	0.32	0.40	0.31	0.35	0.46
Agriculture	5	2- and 10-year	0.08	0.13	0.16	0.11	0.15	0.21	0.14	0.19	0.26	0.18	0.23	0.31
		25-, 50-, and 100-year	0.14	0.18	0.22	0.16	0.21	0.28	0.20	0.25	0.34	0.24	0.29	0.41
Open Space	2	2- and 10-year	0.05	0.10	0.14	0.08	0.13	0.19	0.12	0.17	0.24	0.16	0.21	0.28
		25-, 50-, and 100-year	0.11	0.16	0.20	0.14	0.19	0.26	0.18	0.23	0.32	0.22	0.27	0.39
Freeways and Expressways	70	2- and 10-year	0.57	0.59	0.60	0.58	0.60	0.61	0.59	0.61	0.63	0.60	0.62	0.64
		25-, 50-, and 100-year	0.70	0.71	0.72	0.71	0.72	0.74	0.72	0.72	0.73	0.76	0.75	0.78

Source: Wisconsin department of transportation (WDOT), Facilities Development Manual (July 2, 1979), Procedure 13-10-5.

**DETAIL B: RUNOFF COEFFICIENTS (C), FOR SPECIFIC LAND USE**

Land Use	Design Storm 24-Hour Event	Hydrologic Soil Group											
		A			B			C			D		
		Slope Range (%)			Slope Range (%)			Slope Range (%)			Slope Range (%)		
		0-2	2-6	> 6	0-2	2-6	> 6	0-2	2-6	> 6	0-2	2-6	> 6
Row Crops	2- and 10-year	0.08	0.16	0.22	0.12	0.20	0.27	0.15	0.24	0.33	0.19	0.28	0.38
	25-, 50-, and 100-year	0.22	0.30	0.38	0.16	0.34	0.44	0.30	0.37	0.50	0.34	0.41	0.56
Median Strip, turf	2- and 10-year	0.19	0.20	0.24	0.19	0.22	0.26	0.20	0.23	0.30	0.20	0.25	0.30
	25-, 50-, and 100-year	0.24	0.26	0.30	0.25	0.28	0.33	0.26	0.30	0.37	0.27	0.32	0.40
Slide Slope, turf	2- and 10-year	--	--	0.25	--	--	0.27	--	--	0.28	--	--	0.30
	25-, 50-, and 100-year	--	--	0.32	--	--	0.34	--	--	0.36	--	--	0.38
<b>Pavement:</b>													
Asphalt		0.70-0.95											
Brick		0.70-0.80											
Concrete		0.80-0.95											
Drives and Walks		0.75-0.85											
Roofs		0.75-0.95											
Gravel Roads Shoulders		0.40-0.60											

Source: Wisconsin department of transportation (WDOT), Facilities Development Manual (July 2, 1979), Procedure 13-10-5.

**Note:** The lower "C" values in each range should be used with the relatively low intensities associated with 2- to 10-year design recurrence intervals whereas the higher "C" values should be used for intensities associated with the longer 25- to 100-year design recurrence intervals.

**Note:** In parking lot runoff, visible sheen has been accepted as having an oil concentration of 15 mg/L.



**A-82.36 (4)-3. OTHER METHODS OR MODELS.** A model that calculates peak flow such as TR-55, P8 or an equivalent methodology may be used.

Information on how to access P8 is available at the department of natural resources webpage: <http://dnr.wi.gov/runoff/models/> or contact the stormwater coordinator in the runoff management section of the bureau of watershed management at the department of natural resources at phone 608-267-7694.

A simplified TR-55 approach, TR-55 (210-vf-TR-55, second edition, June 1986), may be obtained by accessing the USDA NRCS webpage: <http://dnr.wi.gov/runoff/models/>.

**A-82.36 (6)-1. THE FORMULA FOR SOLVING FOR DIAMETER, D FOR ROOF CONDUCTORS.**

$$D=1.128\sqrt{\frac{A}{X}}$$

Where, A=the area of the roof in square feet.

X=one of the following:

300 square feet per square inch for a roof covered with gravel or slag and with a pitch not exceeding ¼ inch per foot.

250 square feet per square inch for a roof covered with gravel or slag and with a pitch of greater than ¼ inch per foot.

200 square feet per square inch for a roof with a metal, tile, brick or slate covering and with any pitch.

**A-82.36 (8) (a) SAFETY CODE FOR ELEVATORS AND ESCALATORS.** Safety code for elevators and escalators as specified in ASME A17.1–2007 reads:

**ASSME A17.1–2007 SECTION 2.2, PITS 2.2.2 Design and Construction of Pits**

**2.2.2.4** Drains and sump pumps, where provided, shall comply with the applicable plumbing code, and they shall be provided with a positive means to prevent water, gases, and odors from entering the hoistway.

**2.2.2.5** In elevators provided with Firefighters' Emergency Operation, a drain or sump pump shall be provided. The sump pump/drain shall have the capacity to remove a minimum of 11.4 m<sup>3</sup>/h (3,000 gal/h) per elevator.

**2.2.2.6** Sumps and sump pumps in pits, where provided, shall be covered. The cover shall be secured and level with the pit floor.

**A-82.36 (9) (b) AREA DRAIN INLETS.**

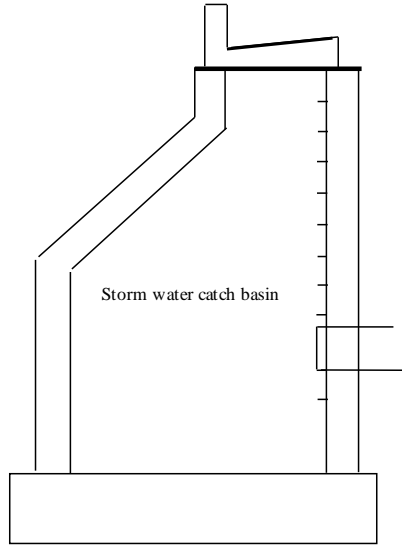
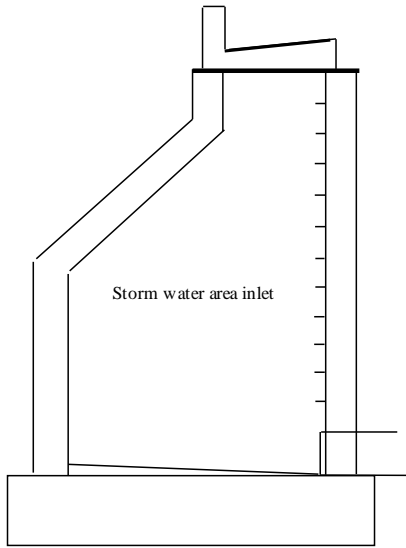

**A-82.36 (9) (b) 3. INLET GRATES.**

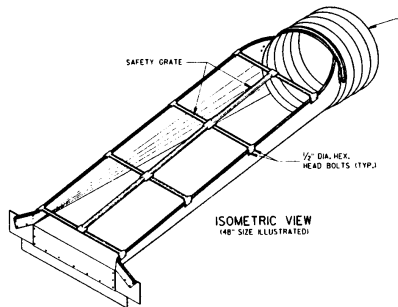

GRATES FOR HORIZONTAL PIPING

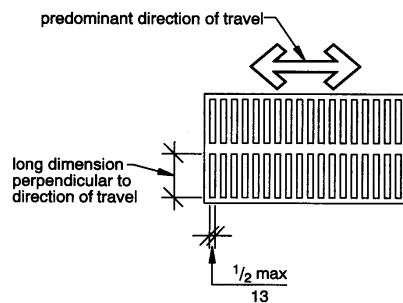

GRATES FOR VERTICAL PIPING

FORMULA TO CALCULATE CAPACITY, IN CUBIC FEET PER SECOND:

$$Q = \frac{2}{3} A C (2gh)^{1/2}$$

Where : Q = the capacity of the inlet, cfs

$\frac{2}{3}$  = a factor to correct for assumed blockage of  $\frac{1}{3}$  of the inlet's net open area

A = the net open area of the inlet, sq. ft

C = an orifice coefficient, usually taken as 0.60

G = a constant, 32.2 ft/sec/sec

H = the head, in feet on the inlet, or the depth of water on top of the inlet, usually not more than two or three inches.

**A-82.365 (1) CLASS V INJECTION WELLS.** An injection well is described as being any well, drilled or dug hole, used to inject fluids into the subsoil. A stormwater collection well may be a class V injection well.

Federal regulations (40 CFR 144.26) require that all injection wells be reported to the state underground injection control (UIC) program authority for the purpose of developing a state inventory of injection practices. In Wisconsin, the department of natural resources, bureau of drinking water and groundwater, maintains this inventory and registration program, form 3300-253. For more information, refer to [www.dnr.state.wi.us/](http://www.dnr.state.wi.us/).

**A-82.37 (3) CAMPSITE RECEPTORS AND WATER SUPPLY**

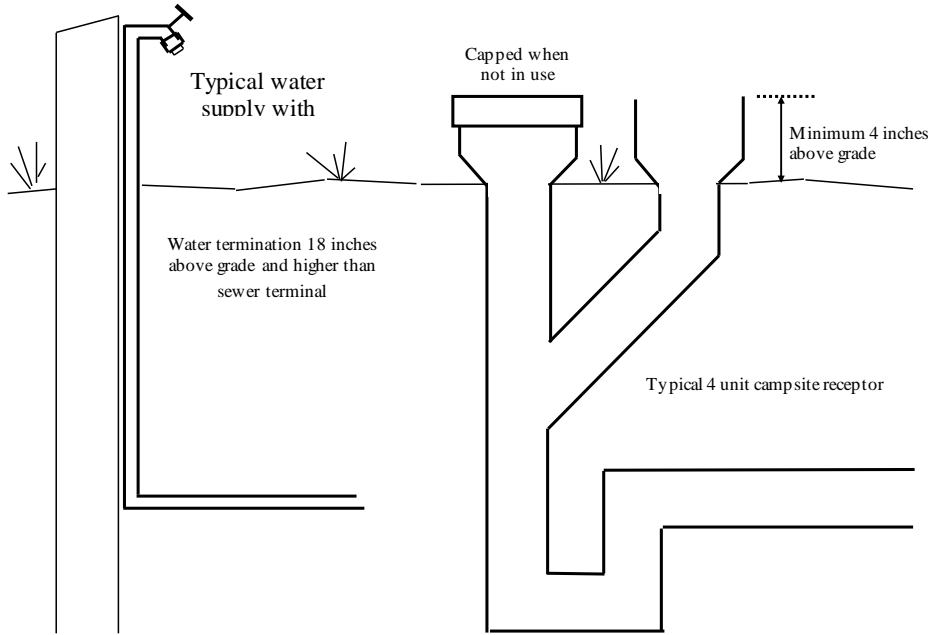

**A-82.40 (4) CONTROL VALVES.**

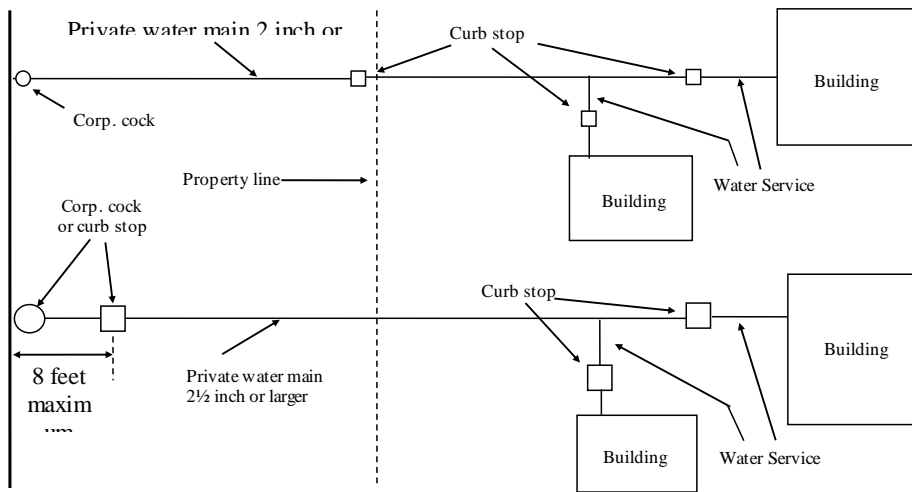

**A-82.40 (5) PIPING INSULATION.** The following is a reprint of s. Comm 63.1029 (1) and (2) and Table 63.1029.

**Comm 63.1029 Insulation, materials and construction. (1) GENERAL.** Insulation required by subs. (2) and (3) shall be suitably protected from damage. Insulation shall be installed in accordance with practices acceptable to the department. The department accepts MICA Commercial and Industrial Insulation Standards as an insulation installation practice.

**(2) PIPING INSULATION.** Except as provided in pars. (a) to (c), recirculating plumbing system piping, plumbing piping in the first 8 feet from storage tanks for noncirculating systems, any piping served by a self-regulating electric heating cable, HVAC system piping, and related HVAC fluid conveying conduit, such as heat exchanger bodies, shall be thermally insulated in accordance with Table 63.1029 or equivalent. The following piping or conduit is exempted from this subsection:

- (a) Factory-installed piping or conduit within HVAC equipment tested and rated in accordance with s. Comm 63.1020.
- (b) Piping or conduit for which no insulation is specified in Table 63.1029.
- (c) Where it can be shown that the heat gain or heat loss to or from piping or conduit without insulation will not increase building energy use.

**PLUMBING AND HVAC PIPING MINIMUM INSULATION (R-VALUE)**

Fluid Design Operating Temp. Range, °F	Insulation Conductivity <sup>a</sup>		Nominal Pipe Diameter					
	Conductivity Range Btu in./- (h-ft <sup>2</sup> ·°F)	Mean Rating Temp. °F	Runouts <sup>b</sup> up to 2 inches	1 inch and less	1¼ to 2 inches	2½ to 4 inches	5 and 6 inches	8 inches and
<b>Heating Systems (Steam, Steam Condensate and Hot Water)</b>								
Above 350	0.32–0.34	250	R-4.4	R-4.4	R-7.4	R-8.8	R-10.3	R-10.3
251–350	0.29–0.31	200	R-4.8	R-4.8	R-8.1	R-8.1	R-11.3	R-11.3
201–250	0.27–0.30	150	R-3.3	R-3.3	R-5.0	R-6.7	R-6.7	R-11.7
141–200	0.25–0.29	125	R-1.8	R-1.8	R-5.2	R-5.2	R-5.2	R-5.2
105–140	0.24–0.28	100	R-1.8	R-1.8	R-3.6	R-3.6	R-3.6	R-5.4
<b>Domestic and Service Hot Water Systems<sup>c</sup></b>								
105 and greater	0.24–0.28	100	R-1.8	R-3.6	R-3.6	R-5.4	R-5.4	R-5.4
<b>Cooling Systems (Chilled Water, Brine and Refrigerant)<sup>d</sup></b>								
40–55	0.23–0.27	75	R-1.9	R-1.9	R-2.8	R-3.7	R-3.7	R-3.7
Below 40	0.23–0.27	75	R-3.7	R-3.7	R-5.6	R-5.6	R-5.6	R-5.6

a For insulation outside the state conductivity range, the minimum thickness (T) shall be determined as follows:  $T = PR [(1+t/PR)K/k - 1]$ , where T = minimum insulation thickness for material with conductivity K, in.; PR = actual outside radius of pipe, in.; t = insulation thickness, in.; K = conductivity of alternate material at mean rating temperature indicated for the application fluid temperature; and k = the lower value of the conductivity range listed for the applicable fluid temperature.

b Runouts to individual terminal units not exceeding 12 ft. in length.

c Applies to recirculating sections of service or domestic hot water systems and first 8 ft. from storage tank for nonrecirculating systems.

d The required minimum thickness does not consider water vapor transmission and condensation.

**Maximum Allowable Load For PVC Sched. 80, ASTM 1785, (1/2 to 2 inches)**

Press. Loss due to friction A-value	1/2 inch				3/4 inch				1 inch				1 1/4 inches				1 1/2 inches				2 inches			
	GPM	Vel. ft/sec	WSFU		GPM	Vel. ft/sec	WSFU		GPM	Vel. ft/sec	WSFU		GPM	Vel. ft/sec	WSFU		GPM	Vel. ft/sec	WSFU		GPM	Vel. ft/sec	WSFU	
			FM	FT			FM	FT			FM	FT			FM	FT			FM	FT			FM	FT
0.5	0.77	1	---	0.5	1.7	1.2	---	1.5	3.5	1.5	---	3.5	7	1.7	---	9	11	2	4	16	21.6	2.3	7	33
1	1.1	1.5	---	1	2.5	1.8	---	2.5	5	2.2	---	6	10.5	2.6	4	14	16	2.9	5	23	32	3.4	17	60
2	1.6	2.2	---	1.5	3.7	2.7	---	3.5	7.1	3.1	---	9	15.5	3.8	5	21	23.5	4.2	7	39	46	5	40	87
3	2	2.7	---	2	4.6	3.4	---	4.5	9	4	---	12	19	4.7	6	29	29.4	5.3	12	55	57	6.2	69	160
4	2.4	3.2	---	2	5.3	3.9	---	6	10.5	4.6	4	14	22.3	5.5	7	31	34.2	6.2	19	60	67	7.3	97	210
5	2.7	3.6	---	2.5	6	4.4	---	7	11.8	5.2	4	16	25.3	6.3	8	40	38.4	6.9	25	80	75.4	8	134	251
6	2.9	3.9	---	2.5	6.6	4.9	---	8	13	5.7	4	18	27.7	6.9	10	49	42.1	7.6	32	100				
7	3.2	4.3	---	3	7.2	5.3	---	9	14.1	6.2	4	20	30.1	7.5	12	55	45.8	8	39	112				
8	3.4	4.6	---	3	7.7	5.7	---	9	15	6.6	5	21	32.3	8	16	60								
9	3.7	5	---	3.5	8.2	6	---	10	16	7.1	5	22												
10	3.9	5.3	---	3.5	8.7	6.4	---	10	17	7.6	5	23												
11	4.1	5.6	---	4	9.2	6.8	---	12	17.9	8	5	26												
12	4.3	5.8	---	4	9.6	7.1	---	13																
13	4.5	6.1	---	4.5	10.1	7.5	4	14																
14	4.7	6.4	---	4.5	10.5	7.8	4	14																
15	4.8	6.5	---	4.5	10.8	8	4	15																
16	5	6.8	---	6																				
17	5.2	7.1	---	6																				
18	5.3	7.2	---	6																				
19	5.5	7.5	---	6.5																				
20	5.7	7.8	---	6.5																				
21	5.8	7.9	---	6.5																				
22	5.9	8	---	6.5																				
<b>Per 100 feet of length</b>																								

Note: Approved for cold, tempered, and hot water not exceeding 140° Fahrenheit.

**Maximum Allowable Load For PVC Sched. 80, ASTM 1785, (2½ to 6 inches)**

Press. Loss due to friction A-value	2½ inches				3 inches				3 ½ inches				4 inches				5 inches				6 inches			
	GPM	Vel. ft/sec	WSFU		GPM	Vel. ft/sec	WSFU		GPM	Vel. ft/sec	WSFU		GPM	Vel. ft/sec	WSFU		GPM	Vel. ft/sec	WSFU		GPM	Vel. ft/sec	WSFU	
			FM	FT			FM	FT			FM	FT			FM	FT			FM	FT			FM	FT
0.5	35	2.6	20	70	64	3.1	87	195	92	3.3	200	335	130	3.6	425	527	237	4	1,226	1,226	380	4.6	2,546	2,546
1	51	3.8	50	130	91	4.4	196	330	134	4.8	450	550	188	5.2	835	855	344	6	2,213	2,213	569	7	4,647	4,647
2	74	5.6	125	245	132	6.4	436	536	195	7	885	900	274	7.6	1,564	1,564								
3	92	6.9	200	330	164	8	654	717																
4	108	8	288	415																				
Per 100 feet of length																								

Note: Approved for cold, tempered, and hot water not exceeding 140° Fahrenheit.

**Maximum Allowable Load for Schedule 80 CPVC ASTM F 441 Corzan Pipe (3/8 to 2 inches)**

Press. Loss due to Friction A-Value	3/8 inch				1/2 inch				3/4 inch				1 inch				1 1/4 inch				1 1/2 inches				2 inches			
	GPM	Vel. ft/sec	WSFU		GPM	Vel. ft/sec	WSFU		GPM	Vel. ft/sec	WSFU		GPM	Vel. ft/sec	WSFU		GPM	Vel. ft/sec	WSFU		GPM	Vel. ft/sec	WSFU		GPM	Vel. ft/sec	WSFU	
			FM	FT			FM	FT			FM	FT			FM	FT			FM	FT			FM	FT			FM	FT
0.5	0.36	0.8	---	0.25	0.5	0.7	---	0.5	0.6	1.1	---	0.5	3.2	1.5	---	3	6.9	1.8	---	8	10.5	2	4	14	20.7	2.3	6	31
1	0.5	1.2	---	0.5	1	1.5	---	1	2.4	1.8	---	2	4.7	2.1	---	4.5	10	2.6	4	13	15.2	2.9	5	22	30.1	3.4	13	55
2	0.75	1.8	---	0.5	1.5	2.2	---	1.5	3.5	2.7	---	2.5	6.7	3.1	---	8	14.5	3.8	4	20	22.2	4.2	7	35	43.8	4.9	36	106
3	0.97	2.3	---	1	1.7	2.4	---	1.5	4.3	3.3	---	4	8.3	3.8	---	10	18.1	4.7	6	26	27.6	5.2	10	49	54.5	6.1	60	147
4	1.1	2.7	---	1	1.8	2.6	---	1.5	5	3.9	---	6	9.7	4.5	---	12	21.1	5.5	7	32	32.2	6	16	60	63.7	7.1	85	193
5	1.24	3	---	1	2.5	3.6	---	2.5	5.7	4.4	---	6.5	11	5.1	4	15	23.8	6.2	7	39	36.4	6.8	22	74	71.8	8	115	234
6	1.37	3.3	---	1	2.7	3.9	---	2.5	6.2	4.8	---	7	12.1	5.6	4	16	26.3	6.8	9	45	40.1	7.5	30	87				
7	1.5	3.7	---	1.5	2.95	4.3	---	3	6.7	5.2	---	8	13.1	6.1	4	18	28.5	7.4	11	51	42.7	8	34	102				
8	1.6	3.9	---	1.5	3.2	4.6	---	3	7.25	5.6	---	9	14.1	6.5	4.5	20	30.8	8	14	56								
9	1.7	4.1	---	1.5	3.4	4.9	---	3	7.75	6	---	9	15	7	5	21												
10	1.8	4.4	---	1.5	3.6	5.2	---	3.5	8.3	6.4	---	10	15.9	7.4	5	23												
11	1.9	4.6	---	1.5	3.7	5.4	---	3.5	8.7	6.7	---	11	16.8	7.8	5	24												
12	2	4.9	---	2	3.9	5.7	---	3.5	9	7	---	12	17.2	8	5	25												
13	2.08	5.1	---	2	4.1	6	---	4	9.4	7.3	---	12																
14	2.16	5.3	---	2	4.3	6.3	---	4	9.8	7.6	4	13																
15	2.24	5.5	---	2	4.4	6.4	---	4	10.2	8	4	13																
16	2.32	5.7	---	2	4.6	6.7	---	5																				
17	2.4	5.9	---	2	4.8	7	---	5																				
18	2.47	6	---	2	5	7.3	---	6																				
19	2.55	6.2	---	2.5	5.1	7.4	---	6																				
20	2.63	6.4	---	2.5	5.2	7.6	---	6																				
21	2.71	6.6	---	2.5	5.3	7.7	---	6																				
22	2.78	6.8	---	2.5	5.5	8	---	6.5																				
25	3	7.3	---	3																								
30	3.25	8	---	3																								
Per 100 feet of Length																												



**Maximum Allowable Load for Schedule 80 CPVC ASTM F 441 Corzan Pipe (2½ to 10 inches)**

Press. Loss due to Friction A-Value	2½ inches				3 inches				4 inches				6 inches				8 inches				10 inches			
	GPM	Vel. ft/sec	WSFU		GPM	Vel. ft/sec	WSFU		GPM	Vel. ft/sec	WSFU		GPM	Vel. ft/sec	WSFU		GPM	Vel. ft/sec	WSFU		GPM	Vel. ft/sec	WSFU	
			FM	FT			FM	FT			FM	FT			FM	FT			FM	FT			FM	FT
0.5	33.2	2.6	17	64	59.8	3	74	174	125	3.5	393	500	366	4.6	2,416	2,416	768	5.5	7,134	7,134	1,393	6.3	14,756	14,756
1	48.3	3.8	44	121	87	4.3	180	310	181	5.2	784	817	533	6.7	4,117	4,117	1,116	8	11,378	11,378				
2	70.2	5.5	108	226	126	6.3	400	505	281	8	1,629	1,629												
3	87.4	6.8	181	312	157	7.8	600	677																
4	102	8	255	385																				
<b>Per 100 feet of Length</b>																								

**A-82.40 (7) (a) METHODOLOGY.**

Where equipment such as an instantaneous or tankless water heater, water treatment device, water meter, and backflow preventer is provided in the design, the friction loss in such equipment, corresponding to the GPM demand, should be determined from the manufacturer or other reliable source.

Where a direct fired pressurized tank type water heater is provided in the design, the friction loss for such equipment can be assumed as part of the pressure losses due to flow through piping, fittings, valves and other plumbing appurtenances when the developed length of piping is multiplied by 1.5.

The pressure losses due to flow friction through displacement type cold-water meters may be calculated from Graph A-82.40 (7)-1.

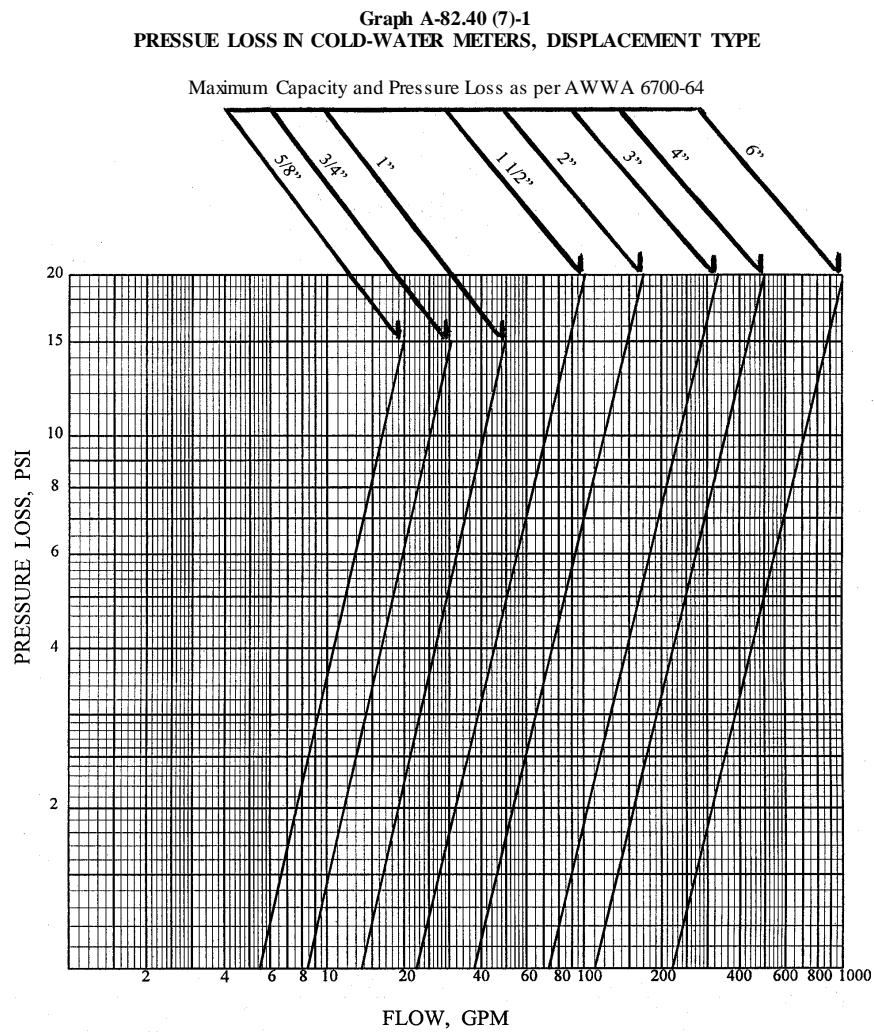

**Graph A-82.40 (7)-2**  
**PRESSURE LOSSES DUE TO FLOW FRICTION**  
 Material: Copper Tube-Type K, ASTM B88; (C = 150)

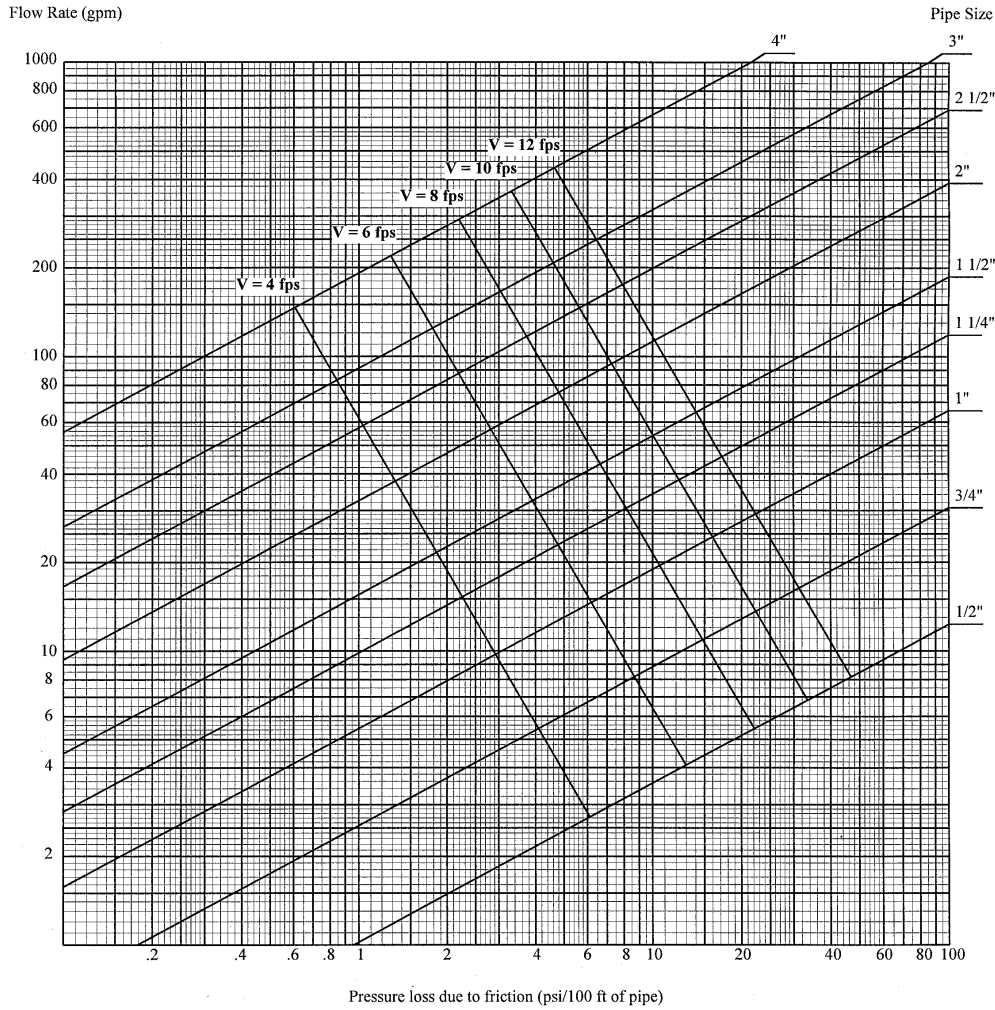

**Graph A-82.40 (7)-3**  
**PRESSURE LOSSES DUE TO FLOW FRICTION**  
 Material: Copper Tube-Type L, ASTM B88; (C = 150)

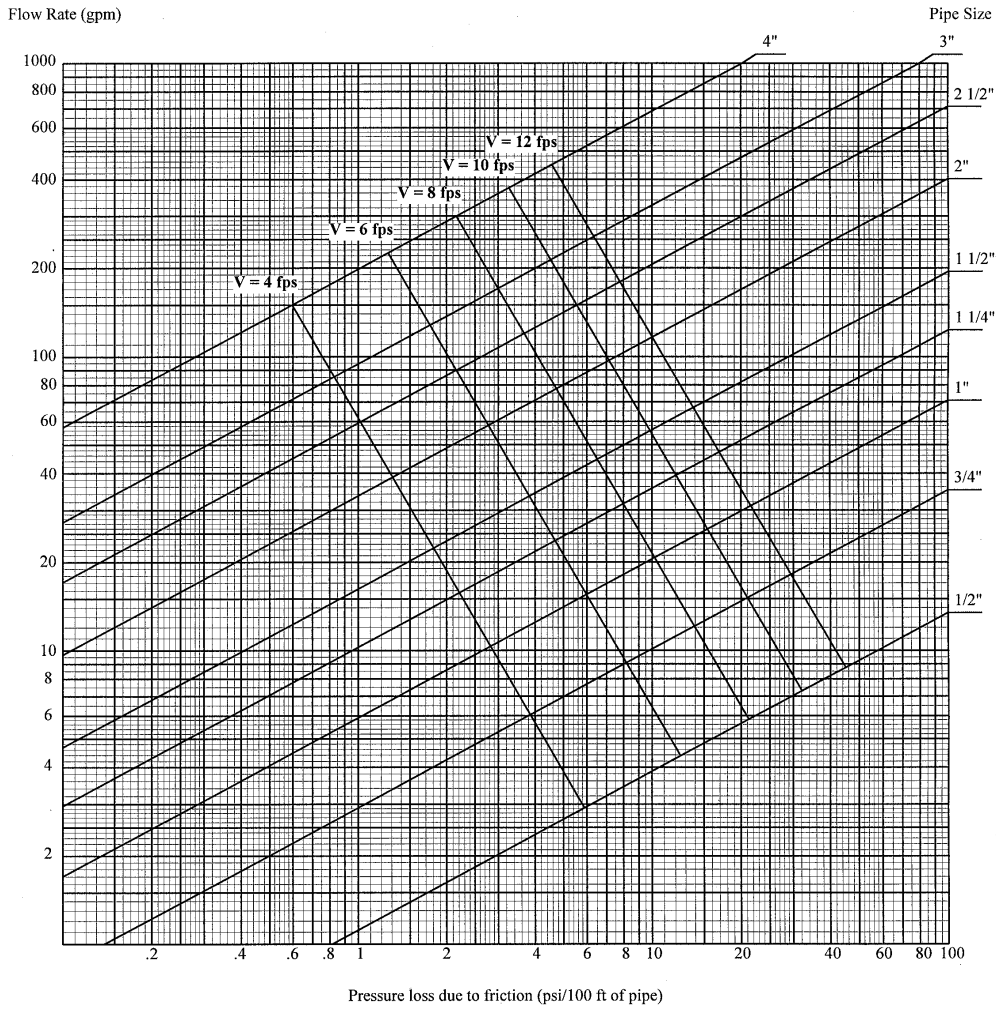

**Graph A-82.40 (7)-4**  
**PRESSURE LOSSES DUE TO FLOW FRICTION**  
 Material: Galvanized Steel Pipe-Schedule 40, ASTM A53, ASTM A120; (C = 125)

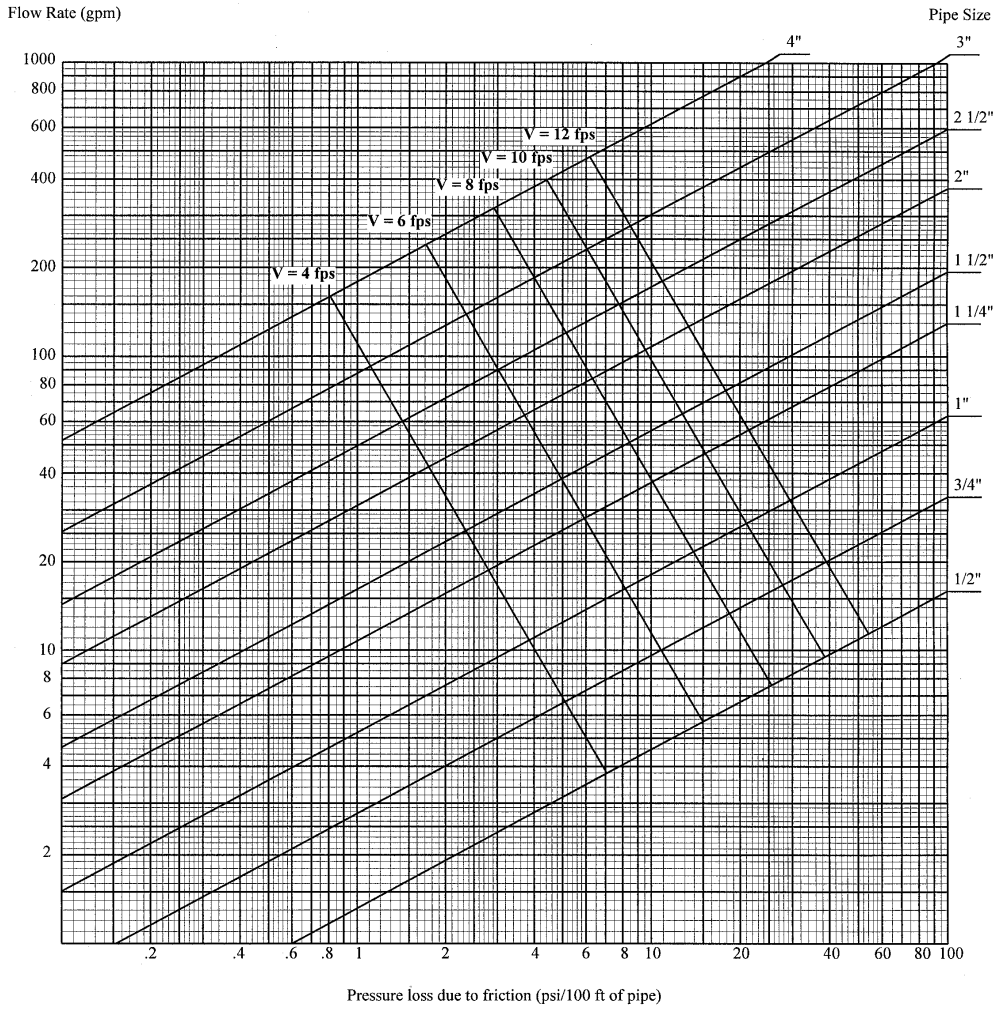

**Graph A-82.40 (7)-5**  
**PRESSURE LOSSES DUE TO FLOW FRICTION**  
 Material: Polybutylene Tubing, ASTM D3309;  
 or CPVC Tubing, ASTM D2846; (C = 150)

Flow Rate (gpm)

Pipe Size

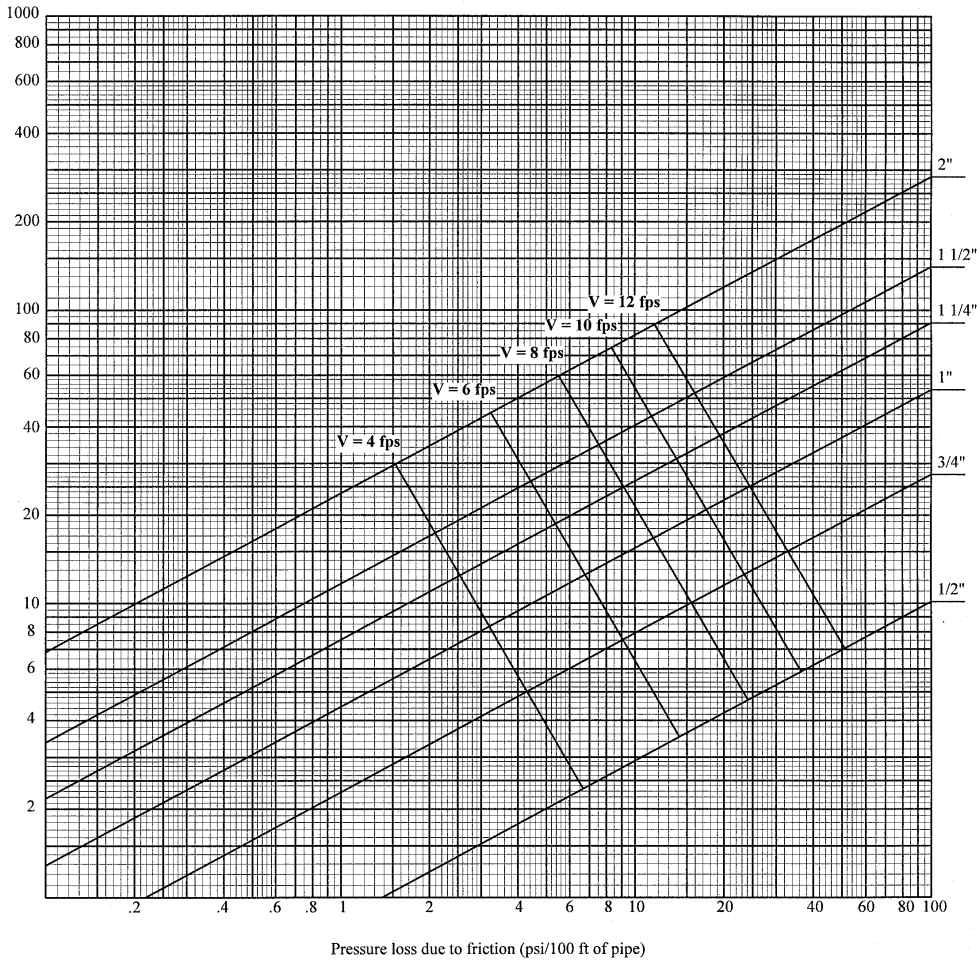

**Graph A-82.40 (7)-6**  
**PRESSURE LOSSES DUE TO FLOW FRICTION**  
 Material: Crosslinked Polyethylene (PEX) Tubing, ASTM F876; (C = 150)

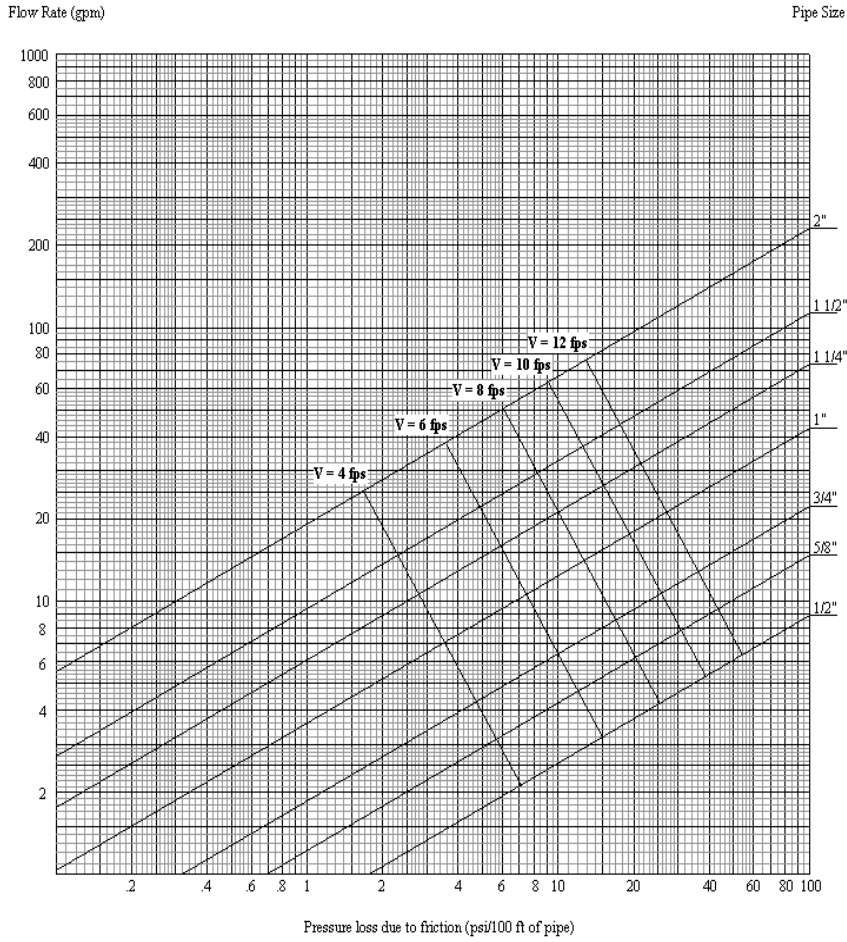

**Graph A-82.40 (7)-7**  
**PRESSURE LOSSES DUE TO FLOW FRICTION**  
 Material: Polyethylene Tubing, Copper Tube Size, ASTM D2737; (C = 150)

Flow Rate (gpm)

Pipe Size

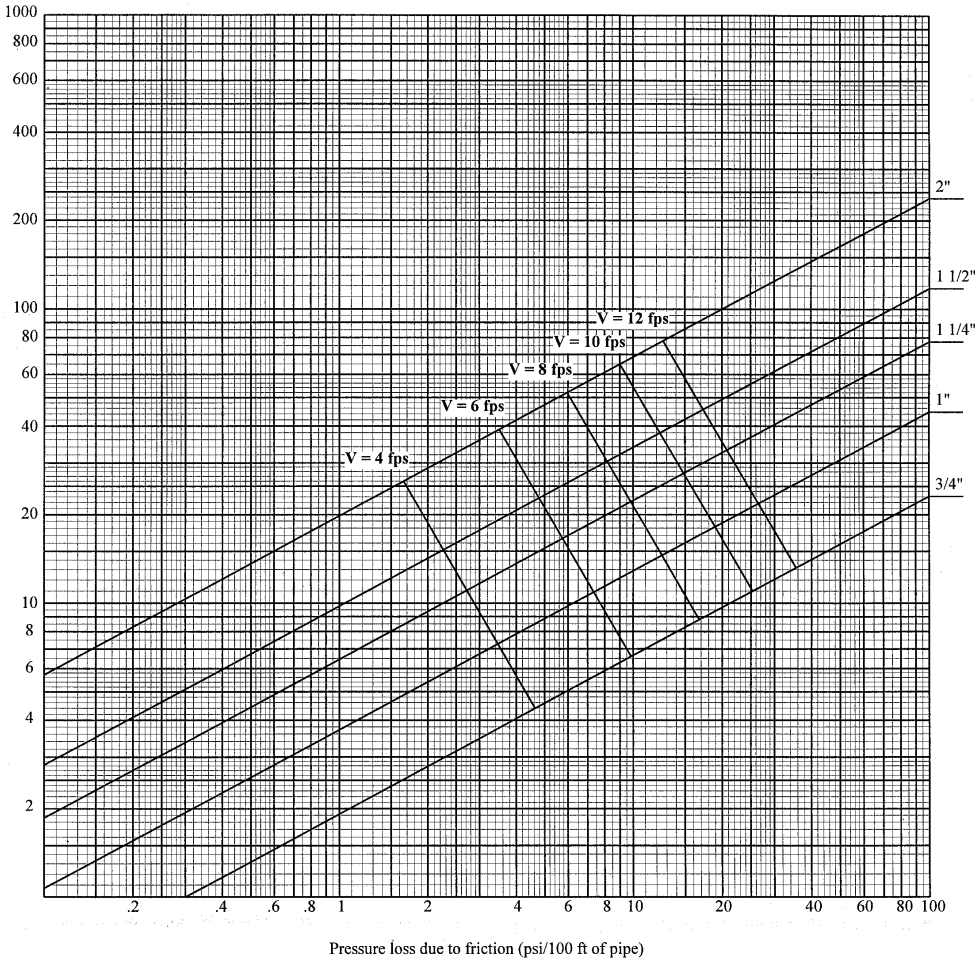



**Graph A-82.40 (7)-8**  
**PRESSURE LOSSES DUE TO FLOW FRICTION**  
 Material: ABS Pipe-Schedule 40; ASTM D1527; or  
 CPVC Pipe-Schedule 40; ASTM F441; or  
 PE Pipe-Schedule 40; ASTM D2104; ASTM D2447; or  
 PVC Pipe-Schedule 40; ASTM D1785; ASTM D2672; (C=150)

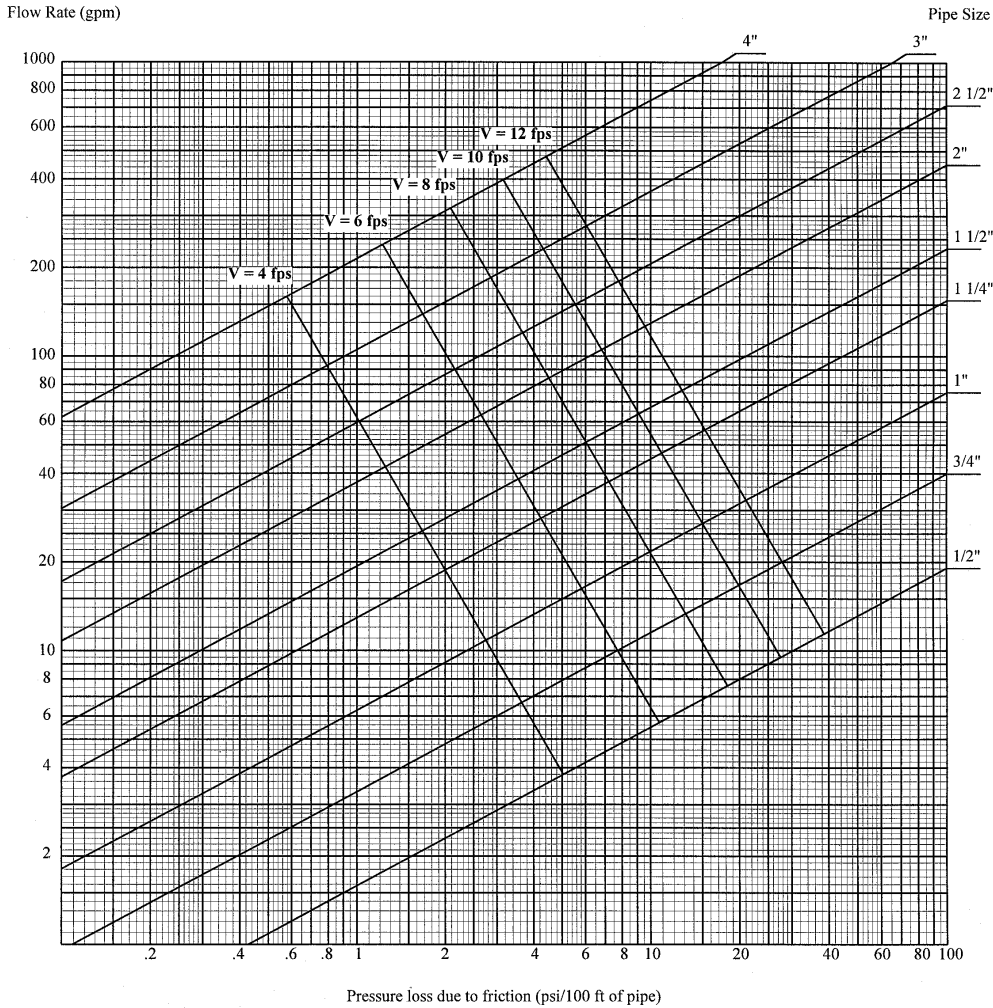

**Graph A-82.40 (7)-9**  
**PRESSURE LOSSES DUE TO FLOW FRICTION**  
 Material: Copper Tube-Type M, ASTM B88; (C = 150)

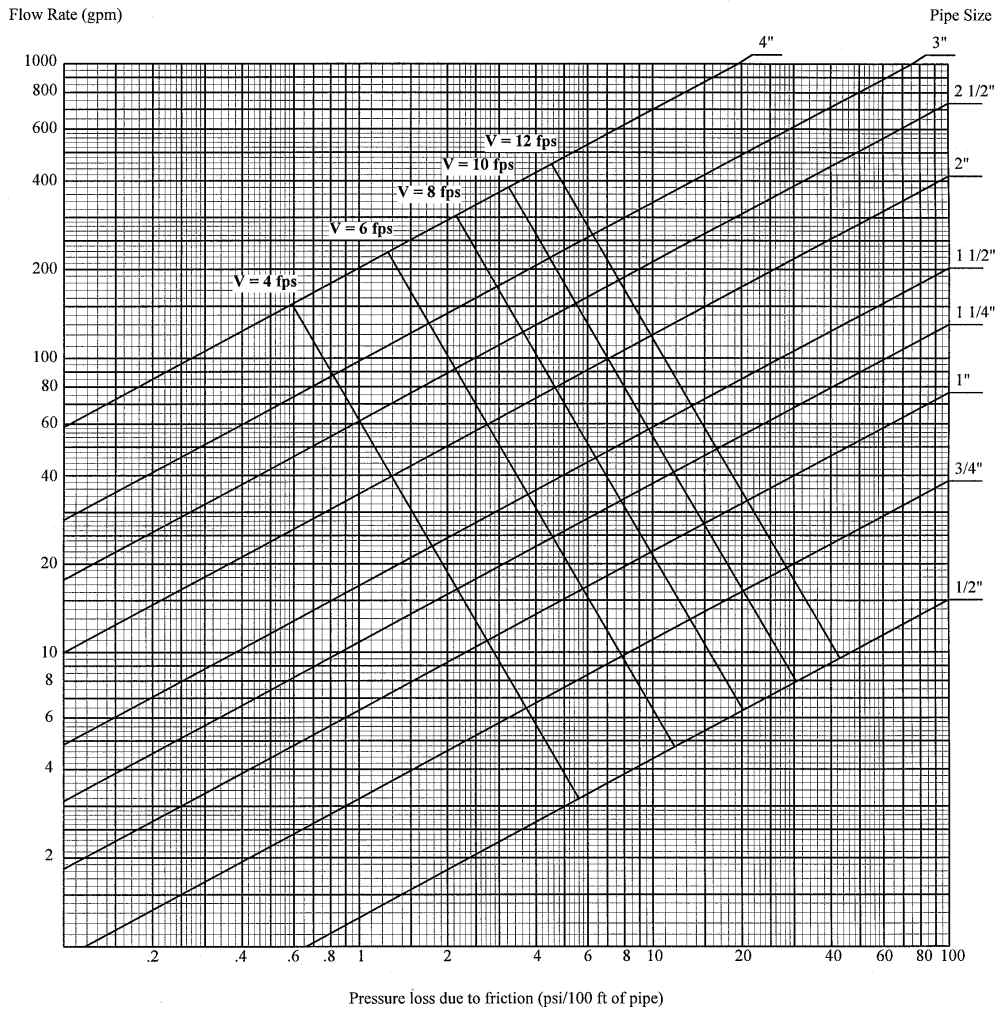

**Graph A-82.40 (7)-10**  
**PRESSURE LOSSES DUE TO FLOW FRICTION**  
 Material: Polyethylene Aluminum Polyethylene Tubing (PexAlPex), ASTM F1281; (C = 150)

Flow Rate (gpm)

Pipe Size

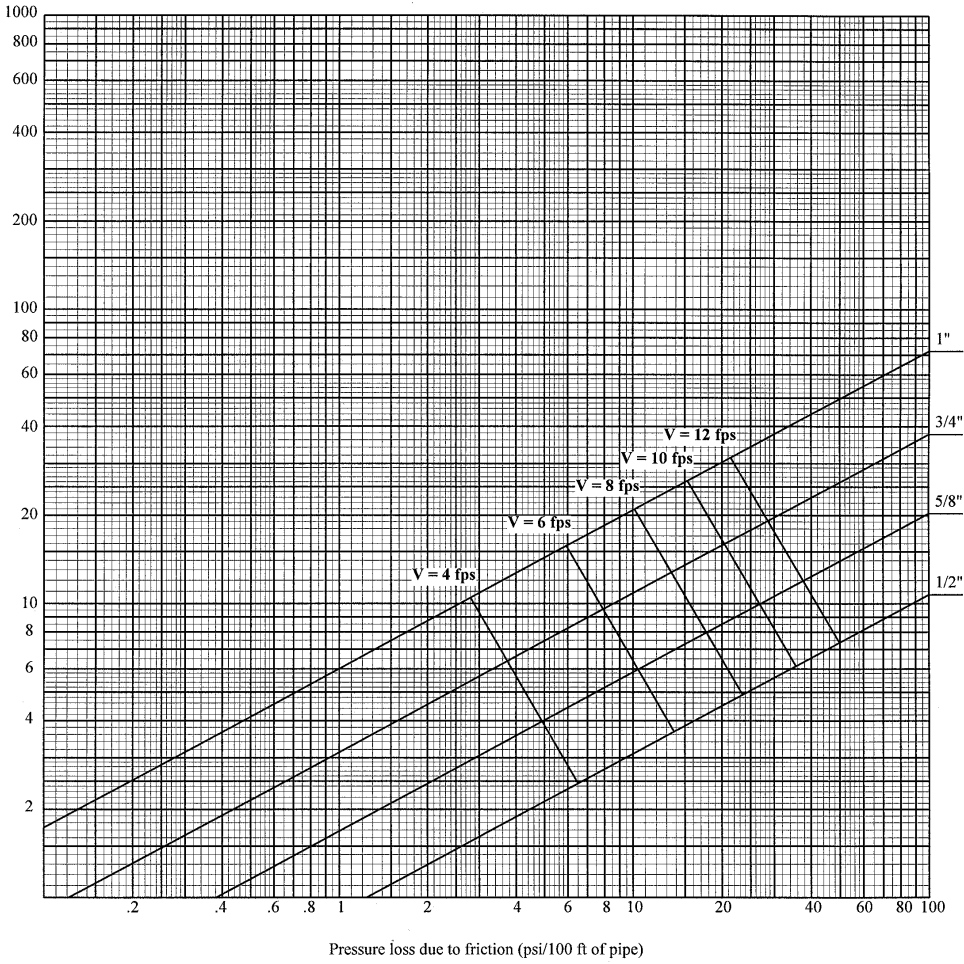

**Graph A-82.40 (7)-11**  
**PRESSURE LOSSES DUE TO FLOW FRICTION**  
 Material: CPVC Tubing, SDR 13.5; ASTM F442; (C = 150)

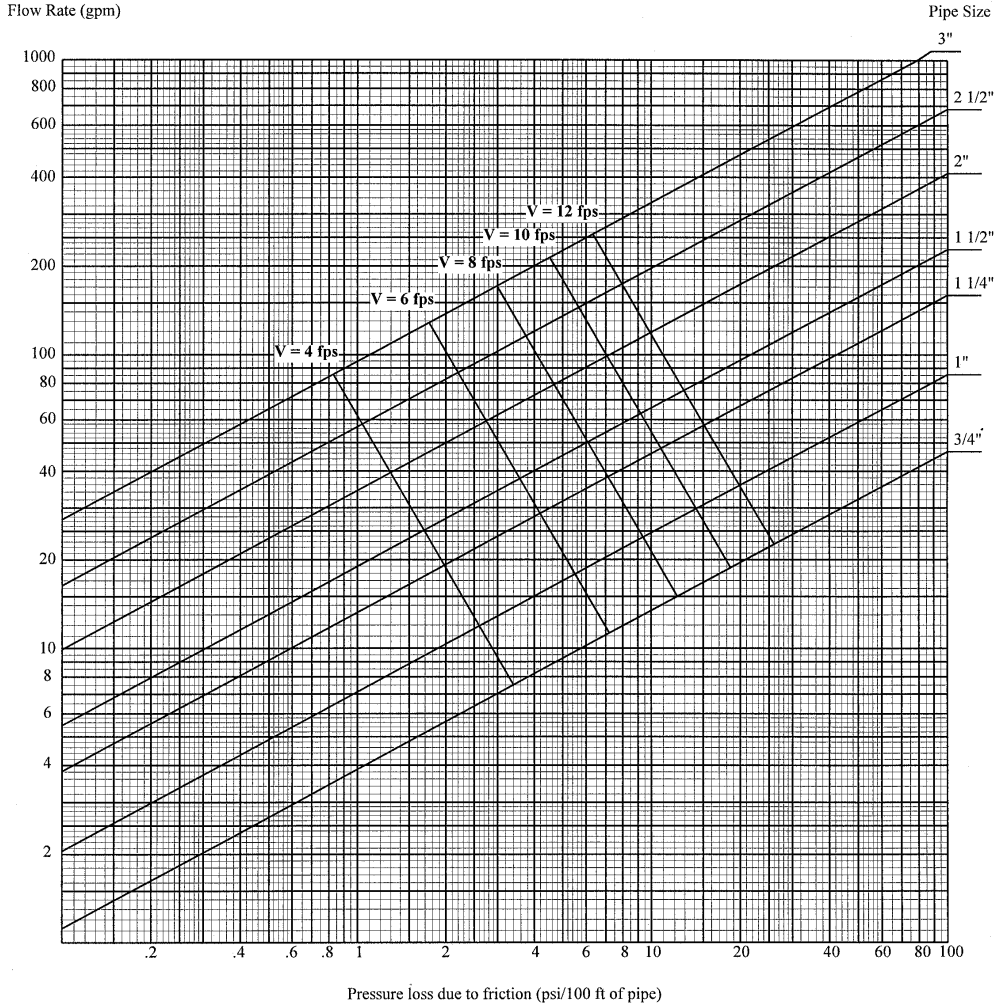

A-82.41 (3) CROSS CONNECTION CONTROL HISTORY.

CROSS CONNECTION CONTROL HISTORY TABLE

Application	Date	Code or Interpretation
Atmospheric vacuum breaker installation	1954	<ul style="list-style-type: none"> <li>• 4 inch elevation above flood level of fixtures</li> </ul>
	1979	<ul style="list-style-type: none"> <li>• 6 inch elevation above flood level of fixtures</li> </ul>
Shampoo Sinks	1977	<ul style="list-style-type: none"> <li>• ASSE 1001 6 inches above the flood level rim</li> <li>• ASSE 1013 or ASSE 1012 serving several sinks</li> </ul>
	3/1/94	<ul style="list-style-type: none"> <li>• Individual CCC required for each sink</li> <li>• ASSE 1001 6 inches above highest point of use (19 inches)</li> <li>• ASSE 1013 or ASSE 1056 12 inches above highest use</li> <li>• ASSE 1014 approved faucet</li> </ul>
Boilers	1977	<ul style="list-style-type: none"> <li>• ASSE 1012 for low pressures:                             <ul style="list-style-type: none"> <li>▪ 15 psig steam</li> <li>▪ 30 psig water</li> </ul> </li> </ul>
	February 1986	<ul style="list-style-type: none"> <li>• ASSE 1012 for boilers:                             <ul style="list-style-type: none"> <li>▪ Pressure <math>\leq</math> 160 psig</li> <li>▪ Rated working temperature <math>\leq</math> 250 degrees</li> <li>▪ Actual temperature <math>\leq</math> 160</li> <li>▪ Pressure relief valve set at 30 psig max.</li> <li>▪ Non-toxic additives</li> <li>▪ Must not be in a hospital (hospital boilers require ASSE 1013)</li> </ul> </li> </ul>
	3/1/94	<ul style="list-style-type: none"> <li>• ASSE 1012 for low pressure (same) and non-toxic in mixed condition</li> <li>• ASSE 1013 for high pressure or toxic</li> </ul>
	12/1/04	<ul style="list-style-type: none"> <li>• Chemical pot feeder creates high hazard situation automatically</li> </ul>
Laundry trays	1977	<ul style="list-style-type: none"> <li>• Residential – no CCC required on hose threads</li> <li>• Commercial – ASSE 1001 required at 7'6"</li> </ul>
	1987	<ul style="list-style-type: none"> <li>• Residential without hose threads – no additional device required</li> <li>• Residential with hose threads – ASSE 1011</li> <li>• Commercial – ASSE 1001 @ 7'6" or ASSE 1011</li> </ul>
	3/1/94	<ul style="list-style-type: none"> <li>• Residential without hose threads – no additional device required</li> <li>• Residential with hose threads – ASSE 1011, ASSE 1001 @ 7'6" or ASSE 1052</li> <li>• Commercial – used for building maintenance with or without hose threads, same as residential with hose threads</li> </ul>
Hose bibb for maintenance	1987	<ul style="list-style-type: none"> <li>• ASSE 1011 or ASSE 1001 @ 7'6"</li> </ul>
	3/1/94	<ul style="list-style-type: none"> <li>• ASSE 1011 or ASSE 1019</li> </ul>
Hose reels	1977	<ul style="list-style-type: none"> <li>• ASSE 1001 with stipulations or ASSE 1013</li> </ul>
	3/1/94	<ul style="list-style-type: none"> <li>• ASSE 1020 (exterior only) with stipulations</li> <li>• ASSE 1056 with stipulations or ASSE 1013</li> </ul>
Sink overhead	1987	<ul style="list-style-type: none"> <li>• ASSE 1012 or</li> <li>• Spring making cross connection impossible</li> </ul>
Heat exchangers	1986	<ul style="list-style-type: none"> <li>• Double wall draining to atmosphere with toxic heat transfer fluids</li> <li>• Single wall when non-toxic heat transfer fluids</li> </ul>
Yard hydrants	July 1987	<ul style="list-style-type: none"> <li>• Sanitary hydrant with ASSE 1011 or</li> <li>• ASSE 1012 serving only that hydrant and label hydrant as "non-potable" and hose threads protected with ASSE 1011</li> </ul>
	9/1/01	<ul style="list-style-type: none"> <li>• Must be sanitary hydrant <b>without below ground bleed</b></li> </ul>

Application	Date	Code or Interpretation
ASSE 1012	3/1/94	• Limited to low degree of hazard
ASSE 1019	3/1/94	• Exterior wall hydrants must be frost proof and self draining • The backflow protection must be integral to the hydrant
Dental units	October 1987	• ASSE 1012 for each individual dental unit
	3/1/94	• ASSE 1013 (high hazard designation)
Existing fire protection	2/1/94	• Allow existing CCC to remain unless increase in diameter of H2O dist, or remove or replace CCC

**A-82.41(5)(a) AIR-GAP.** An air-gap for cross connection control for water supply systems conforming to ASME 112.1.2.

**Section Comm 81.01 (7) reads:** “‘Air-gap, water supply system,’ means the unobstructed vertical distance through the free atmosphere between the lowest opening from any pipe or faucet supplying water to a tank or plumbing fixture and the flood level rim or spill level of the receptacle.”

A pipe/spout that terminates with its outlet above the flood level rim of a receptacle/fixture:

1. Shall terminate a minimum of one inch above the flood level rim of the receptacle/fixture, or
2. Shall terminate a minimum distance of two times the diameter of the effective opening from the end of the pipe/spout to the flood level rim of the receptacle/fixture.

**Note:** In any case, **regardless** if the end of the pipe/spout is cut square or at an angle, the air-gap is the distance between the lowest end of the pipe/spout and the flood level rim of the receptacle/fixture.

The following water supply air-gap, although the least desirable, is acceptable to the ASME 112.1.2 standard. A pipe/spout that terminates with its outlet completely below the flood level rim of a receptacle/fixture:

1. Must have an opening in the receptacle/fixture that discharges to the atmosphere through an air-gap.
2. This air-gap must be located as close as possible to the receptacle/fixture.
3. The rate of discharge through this opening as compared to the rate of water entering the receptacle/fixture establishes a “spill level” that is the level at which water entering the receptacle/fixture seeks a balance and does not raise any higher. (A level is established where the flow of water entering equals the flow of water exiting.)
4. The distance then, between this established “spill level” and the end of the lowest water supply pipe/spout is the air-gap.
5. The minimum air-gap (“Y”) is the distance between the supply pipe/spout and the “spill level” established in the receptacle/fixture.
6. The “spill level” shall be a distance no greater than one half of the distance measured as “Y,” ( $\frac{1}{2}$  “Y”) above the discharge opening in the receptacle/fixture. Therefore, the air-gap between the supply pipe/spout and the highest portion of the opening that discharges to the atmosphere shall be a distance no greater than one and one half “Y” ( $1\frac{1}{2}$  “Y”).

**Note:** In any case, **regardless** if the end of the pipe/spout is cut square or at an angle, the air-gap is the distance between the lowest end of the pipe/spout and the “spill level” of the receptacle/fixture.

The measurement for this air-gap, however, could be as much as 3 times the diameter of the pipe/spout depending upon the number of near walls. The distance of a near wall is a relationship to the diameter of the pipe/spout and the measurement from the wall to the closest side of the pipe/spout:

1. If there is one near wall, and the distance between that near wall and the closest edge of the supply pipe/spout is greater than 3 times the diameter of the supply pipe/spout, then the minimum air-gap is 2 times the diameter of the supply pipe/spout.
2. If there is one near wall, and the distance to the closest edge of the supply pipe/spout is less than 3 times the diameter of the pipe/spout, then the minimum air-gap is 3 times the diameter of the supply pipe/spout.
3. If there are 2 near walls, and the distance between the near wall(s) and closest edge of the supply pipe/spout is greater than 4 times the diameter of the supply pipe/spout, then the minimum air-gap is 2 times the diameter of the supply pipe/spout.
4. If there are 2 near walls, and the distance to the closest edge of the supply pipe/spout is less than 4 times the diameter of the supply pipe/spout, then the minimum air-gap is 3 times the diameter of the supply pipe/spout.

It has been determined that 2 or more near walls generally have little effect on the need to increase the air-gap to more than 3 times the diameter of the supply pipe/spout.

**Note:** See the following sketches as examples of an air-gap with pipe/spouts terminating above the flood level rim of the receptacle/fixture, of an air-gap with pipe/spouts terminating below the flood level rim of the receptacle/fixture and of an air-gap with pipe/spouts when terminating by one near wall.

**A-82.41 (5)-1. AIR-GAP WITH PIPE/SPOUT(S) ABOVE FLOOD LEVEL RIM OF RECEPTACLE/FIXTURE.**

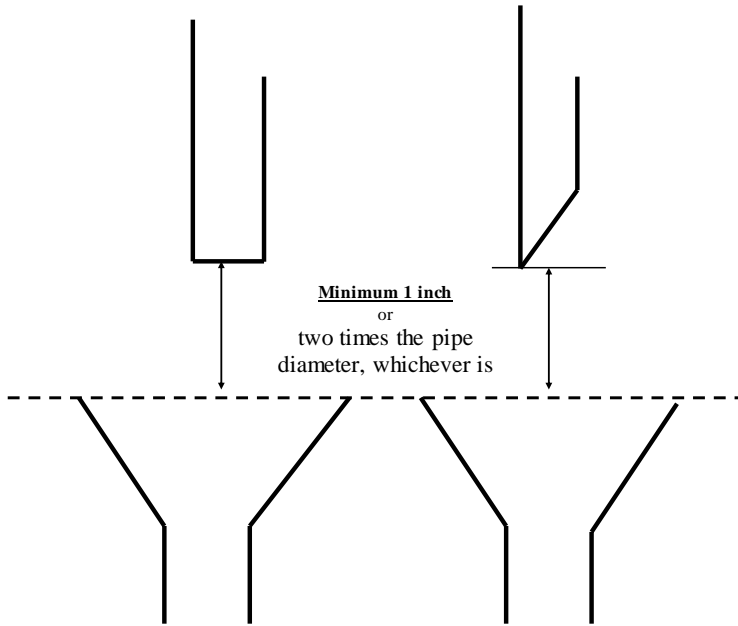

WATER SUPPLY AIR-GAP ASME 112.1.2

**A-82.41 (5)-2. AIR-GAP WITH PIPE/SPOUT(S) BELOW FLOOD LEVEL RIM OF RECEPTACLE/FIXTURE.**

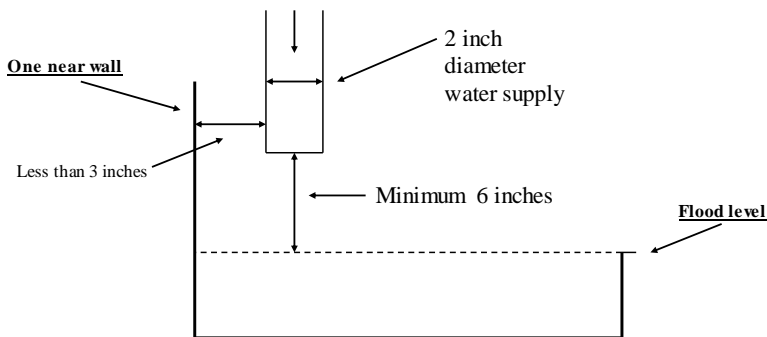
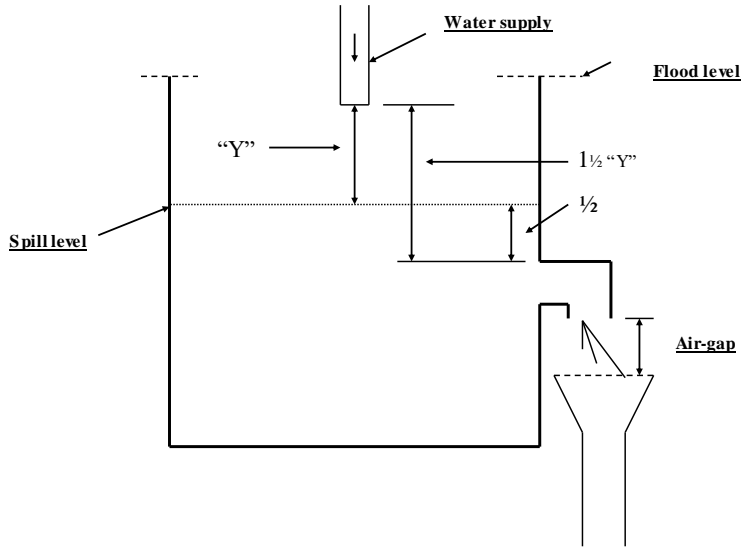

If distance is 3 times or greater than the diameter of water supply (2 inch), then the air-gap is 2 times the diameter of the water supply, (i.e.  $2 \times 2 = 4$  inches)

If the distance is less than 3 times the diameter of the water supply (2 inch), then the air-gap is 3 times the diameter of the water supply, (i.e.  $3 \times 2 = 6$  inches)



**A PARTIAL TABLE FOR THE SELECTION OF BACKFLOW PROTECTION \***

<b>Situation</b>	<b>Hazard</b>	<b>Air-gap</b>	<b>ASSE 1001</b>	<b>ASSE 1011</b>	<b>ASSE 1012</b>	<b>ASSE 1013</b>	<b>ASSE 1014</b>	<b>ASSE 1019</b>	<b>ASSE 1020</b>	<b>ASSE 1022</b>	<b>ASSE 1035</b>	<b>ASSE 1052</b>	<b>ASSE 1055</b>	<b>ASSE 1056</b>
Autoclave/sterilizer <sup>1</sup>	Low				X									
Autoclave/sterilizer <sup>2</sup>	High					X								X
Boiler	Low				X									
Boiler	High					X								
Building maintenance sink <sup>3</sup>	High		X	X		X						X		X
Carbonated beverage dispenser	High									X				
Cappuccino machine	Low				X					X				
Chemical dispensing system <sup>4</sup>	High	X	X			X							X	X
Commercial dishwasher	High		X			X								X
Commercial clothes washer	High	X	X			X								X
Commercial overhead hose reel	High					X								
Dental unit/chair <sup>5</sup>	High					X								X
Espresso machine	Low				X					X				
Exterior wall hydrants	High							X						
Food waste grinder	High		X			X								X
Handheld showers	High		X				X							
Hose threaded outlets <sup>6</sup>	High			X								X		
Humidifier	Low	X			X									
Kidney dialysis machine	High					X								X
Laboratory sink faucet <sup>7</sup>	High		X								X	X		
Photo developing machine	High					X								X
Proofing oven	Low				X									
Shampoo/barber sink <sup>8</sup>	High		X			X	X							X
Swimming pools	High	X	X	X		X		X	X			X		X
Therapeutic pools	High	X	X	X		X		X	X					X
Wading pools	High	X	X	X		X		X	X					X
Water cooled compressors	High					X								X
X-ray developing machine	High					X								X
Yard hydrants <sup>9</sup>	High			X								X		

\* Any situation may be subject to an alternate approval.

1 If less than 15 pounds steam or 30 pounds water, and nontoxic chemicals.

2 If greater than 15 pounds steam or 30 pounds water and/or toxic chemicals.

3 Requires backflow protection even if there is a plain end spout.

4 Requires separate water supply terminating without a hose thread, or the manufacturer must provide a bleed device to connect to the janitor sink faucet spout.

5 Or, provide bottled water conversion unit.

6 For outlets other than the required ASSE 1019 hydrants.

7 If provided with hose threads or serrated nipple.

8 Faucet meeting ASME A112.18.1M that includes backflow protection requirements.

9 Hydrants that bleed into the ground and/or hydrants that are flush with the grade are prohibited.

A-82.41 (5) (f)-1. CROSS CONNECTION CONTROL ASSEMBLY INSTALLATION.

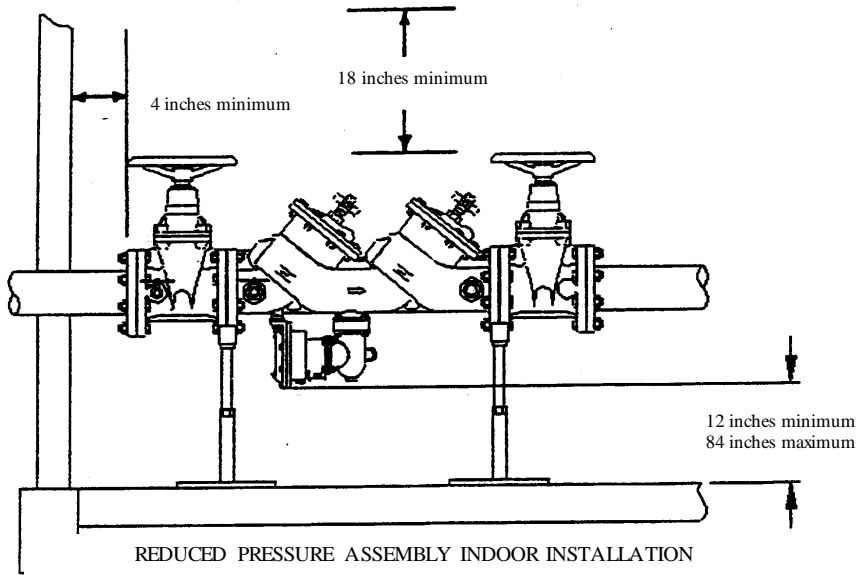
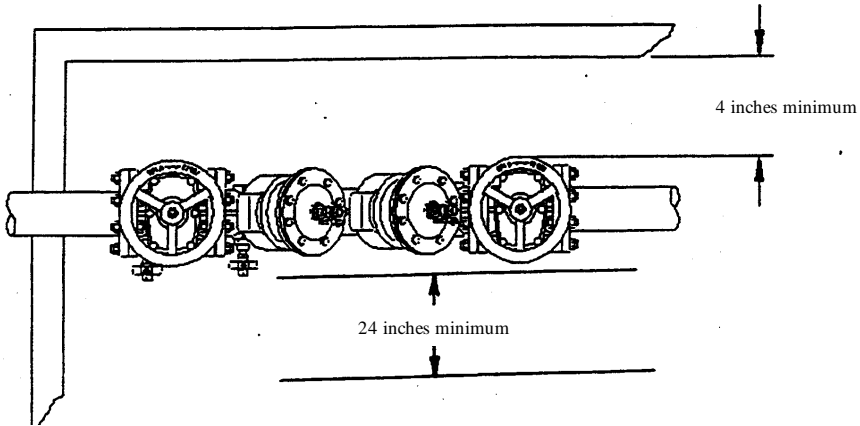

**A-82.41 (5) (f)-2. CROSS CONNECTION CONTROL ASSEMBLY INSTALLATION.**

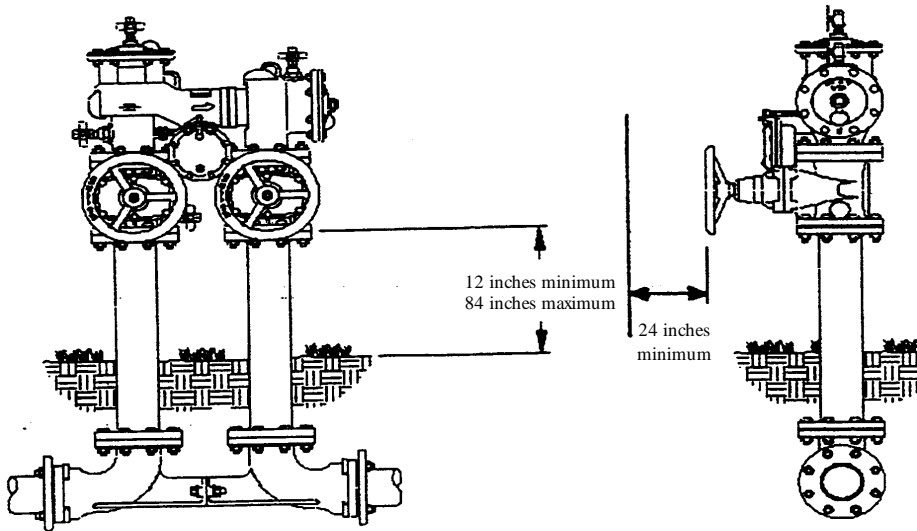

REDUCED PRESSURE ASSEMBLY OUTDOOR INSTALLATION

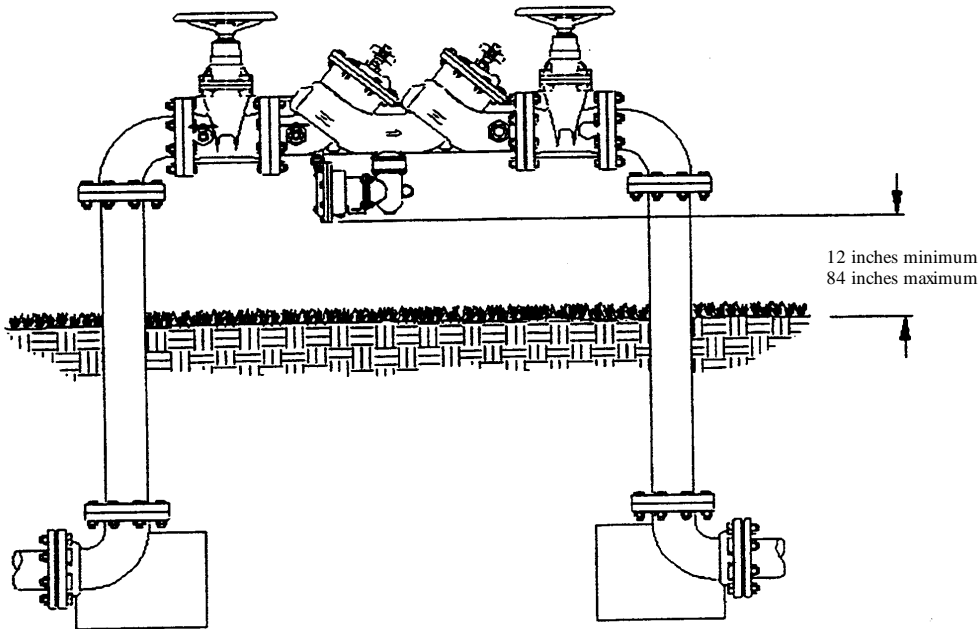

REDUCED PRESSURE ASSEMBLY OUTDOOR INSTALLATION

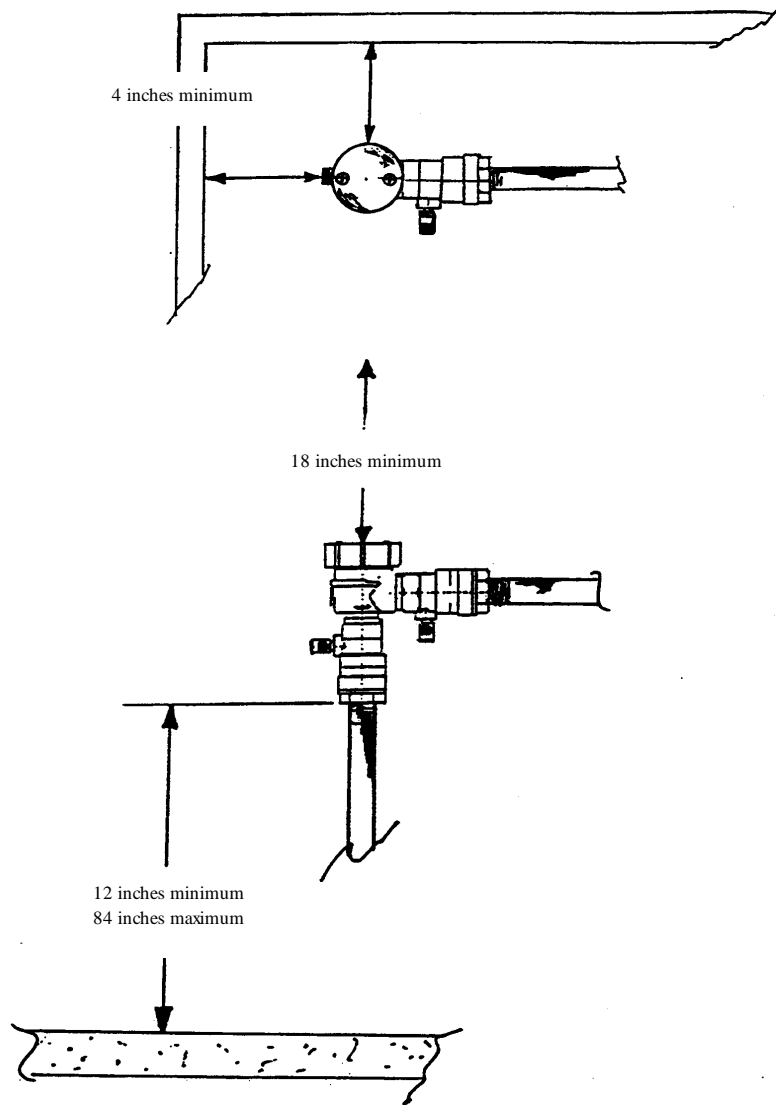

PRESSURE VACUUM BREAKER ASSEMBLY  
 BACK SIPHONAGE BACKFLOW VACUUM BREAKER

A-82.41 (5) (f)-4. CROSS CONNECTION CONTROL ASSEMBLY INSTALLATION.

4 inches minimum

24 inches minimum

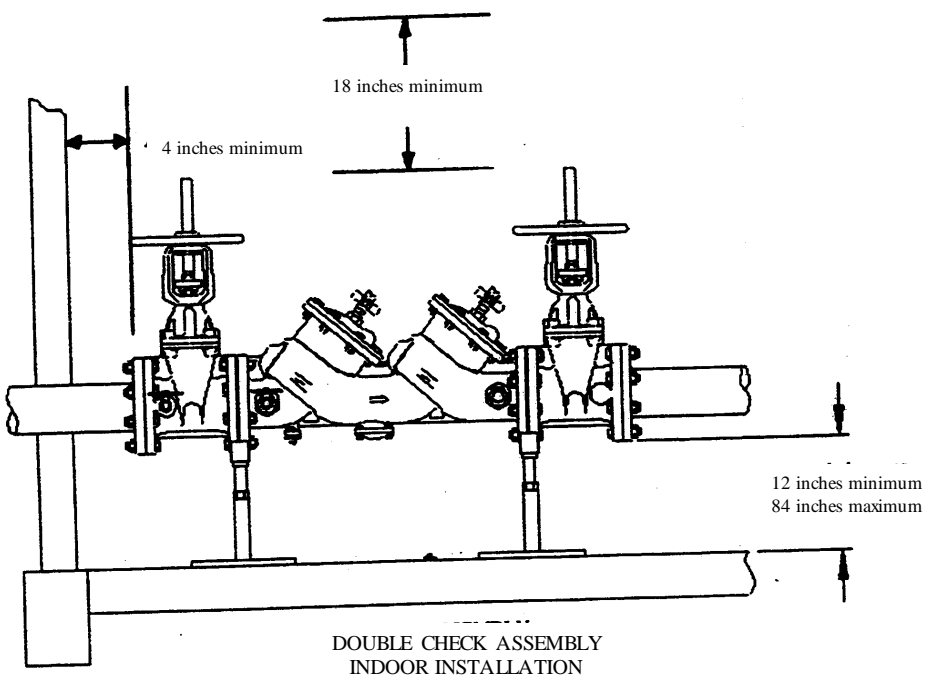
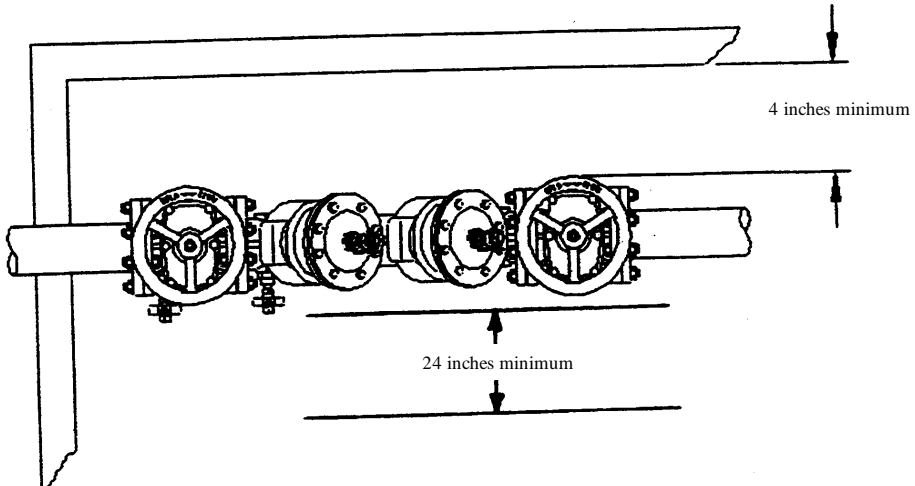

**A-82.50 (3) (b) 5. OPTIONS FOR TEMPERATURE CONTROL IN HEALTH CARE FACILITIES.** The following sketches provide options for fail safe installations at the bathing and shower fixture and temperature control at handwashing fixtures.

**Option 1.** Fail safe solenoid provided at main mixer meeting ASSE 1017, pressure balanced tub/shower valve meeting ASSE 1016 and limit stop faucets at lavatory and kitchen sink.

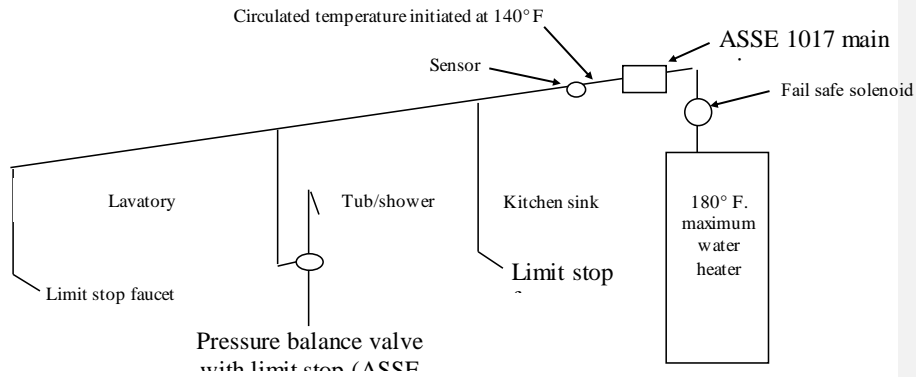

**Option 2.** Fail safe solenoid provided at main mixer meeting ASSE 1017, pressure balanced tub/shower valve meeting ASSE 1016 and thermostatic mixer meeting ASSE 1016 at lavatory and kitchen sink faucets.

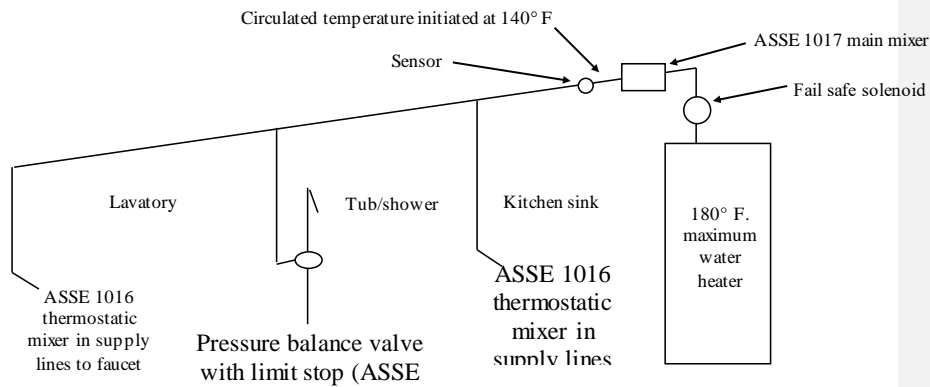



**Option 3.** Fail safe solenoid provided at main mixer meeting ASSE 1017, thermostatic tub/shower valve meeting ASSE 1016 and limit stop faucets at lavatory and kitchen sink.

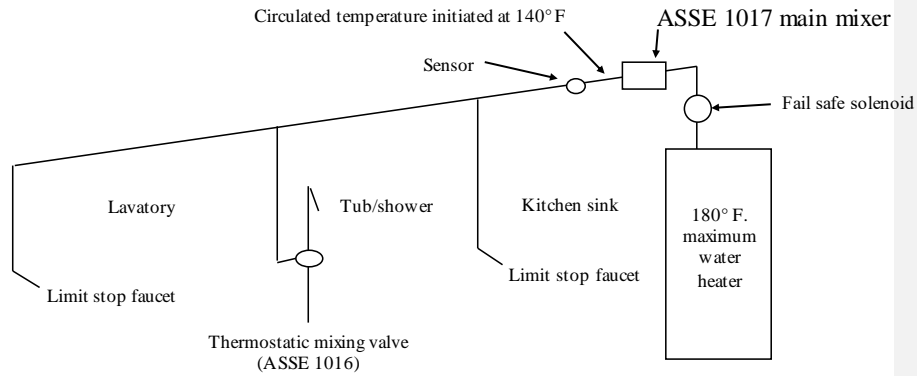

**Option 4.** Fail safe solenoid provided at main mixer meeting ASSE 1017, combination thermostatic/pressure balance mixing valve meeting ASSE 1016 and limit stop faucets at lavatory and kitchen sink.

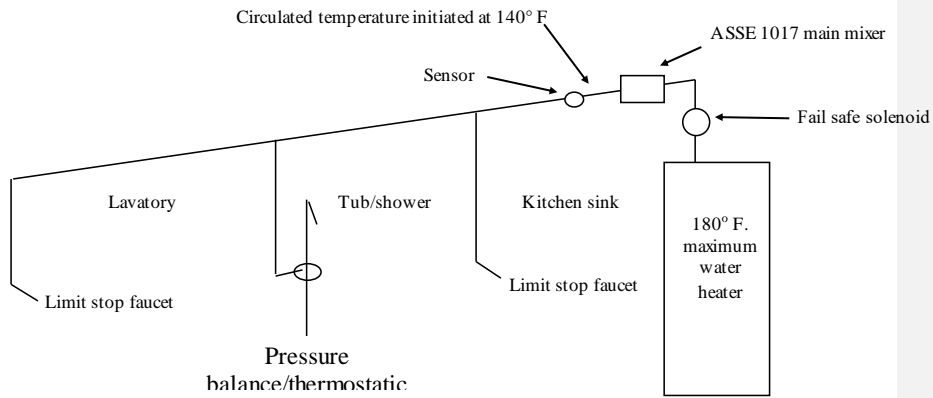

**Option 5.** Fail safe solenoid, combination pressure balanced/thermostatic tub/shower valve meeting ASSE 1016 and thermostatic mixer meeting ASSE 1016 at lavatory and kitchen sink faucets.

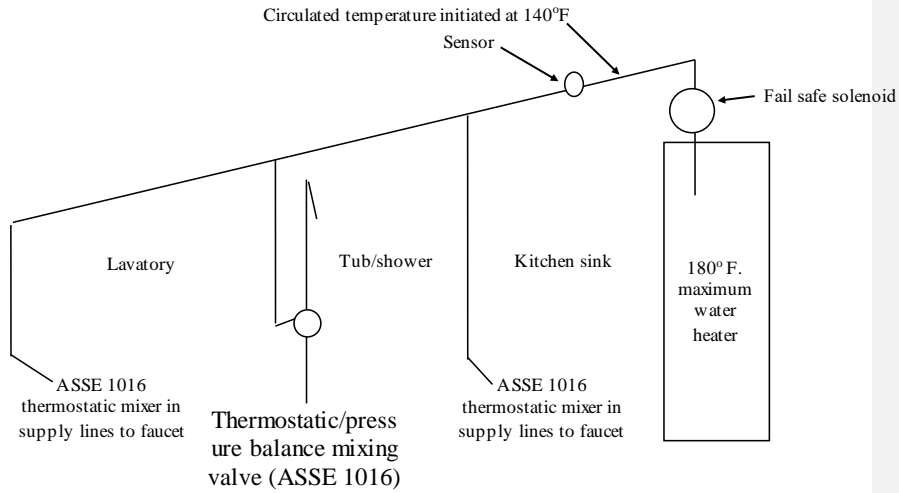

**A-82.51 (3) MOBILE HOME SITES AND PARKS. Mobile home building sewer and water service connections.**

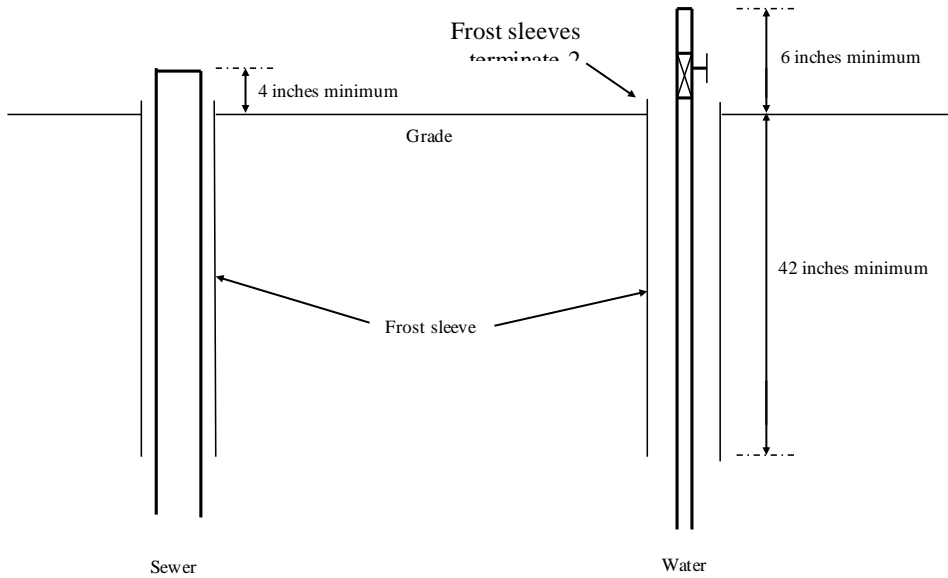

END

\*\*\*\*\*

**EFFECTIVE DATE**

Pursuant to s. 227.22 (2)(intro.), Stats., these rules shall take effect on the first day of the month following the publication in the Wisconsin Administrative Register.

\*\*\*\*\*